

# Josam Specification Drainage Products

2025 List Price Guide

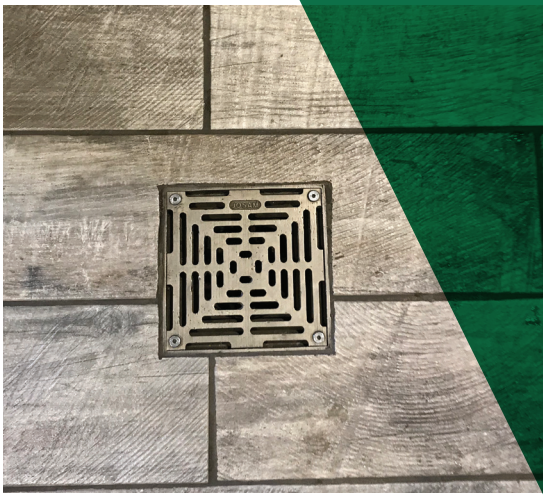

Effective: January 1, 2025

# Josam also offers Stainless Steel Push-Fit Pipe & Fittings, a complete line of Stainless Steel Drains, and the PRO-PLUS® Trench Drain System.

## Stainless Steel Push-Fit Drainage System



- Made of austenitic grade 316L Stainless Steel
- Gasketed "Push-Fit" design for cost effective installations
- 1 1/2" through 8" pipe size
- Specific gasket materials for different product applications
- Pressure ratings at least four times higher than previous generation systems
- Capable of being used in vacuum systems
- Corrosion, Fire, Heat, Impact, & Thermal Stress Resistance
- Strong and Lightweight

## Stainless Steel Drainage Products



- 8", 10", and 12" adjustable and non-adjustable round top floor drains
- 6", 8", 10", 12", and 16" adjustable and non-adjustable square top floor drains
- 2" through 8" no-hub outlets for easy connection to existing piping
- 6", 8", 12", and 16" wide trench drains
- Grates for the lightest to heaviest of loads
- 5/16", 3/4", and 3" slot and mini channels
- Ability to customize products to meet project installation requirements

## PRO-PLUS® Trench Drain System

- SMC/GRP Construction
- 1.5 times stronger than polymer concrete
- 70% Lighter than polymer concrete
- Shatterproof
- Available with and without slope
- 4" and 8" nominal interior widths
- Load Class A-F



For more information on these quality engineered drainage products, please visit [www.josam.com](http://www.josam.com) or contact your local Josam representative.

## TABLE OF CONTENTS

### Specification Products

Closet Carriers .....	3-4
Fixture Carriers.....	5-6
Roof Drains .....	6-10
Floor Drains.....	11-19
Sanitary Floor Sinks.....	19-21
Stainless Steel Retrofit Liners for Sanitary Floor Sinks.....	22
Cleanouts.....	23-25
Interceptors.....	26-30
Backwater Valves .....	31
Hydrants .....	32
Shock Absorbers .....	33
Trench Drains.....	33-34
Miscellaneous Products .....	34
Traps & Accessories.....	35-36

### Lite Line Products

Floor Drains.....	37-39
Roof Drains .....	39
Floor Sinks .....	40
Cleanouts.....	40
Interceptors.....	41
Shock Absorbers .....	41
Shallow Trench Drain Products.....	41

### HOW TO USE THIS PRICE GUIDE

Every product in this guide is provided with list prices for the product and its options in a concise table. The description of each option is shown in the lower right corner of each page spread. A thumbnail photo is included for quick identification. All drawings and dimensions are available at [www.Josam.com](http://www.Josam.com).

All prices are list prices. Please consult your local Josam representative for your current multiplier.



*Partial or Full Domestic Content  
on Specification Product Line  
available upon request.*



Effective: January 1, 2025

## List Price Guide – 2025 (LPG-2025)

Supersedes all previously published terms and conditions. Subject to change without notice.

Applicable to all sales of, and contracts to sell products of Josam Company  
CONTACT YOUR JOSAM REPRESENTATIVE FOR DETAILS ON DISCOUNT

### PAYMENT TERMS:

For accounts with established credit, payment terms are 2% cash discount, payable 30 days from date of invoice, net 31 days. Invoices still unpaid after 31 days from date of invoice will be subject to interest charges of 1-1/2% per month. Minimum invoice: \$25.00 net. Confirmed irrevocable letter of credit or cash in advance of shipment is required for accounts without an established line of credit. Any terms and conditions appearing on your orders which are inconsistent with the terms of our quotation and conditions of sale shall be of no effect.

### FREIGHT ALLOWANCE:

Specification Products (Pages 3-35)

All shipments will be F.O.B. Michigan City, Indiana or Service Center. A freight allowance will be made on all shipments of \$5,000.00 net amount or more within the continental USA except for Alaska, Hawaii and Puerto Rico.

Lite Line Products (Pages 36-40)

All shipments will be F.O.B. Michigan City, Indiana or Service Center. A freight allowance will be made on all shipments of \$1,000.00 net amount or more within the continental USA except for Alaska, Hawaii and Puerto Rico.

Specification Product Line products and Lite Line products may not be combined to obtain minimum freight requirements for full freight allowance.

Full freight allowance is limited to normal ground services and does not include charges for specially expedited or guaranteed deliveries requiring air shipment or guaranteed motor freight contracts.

### RETURN POLICY:

Standard catalog material may be returned only upon written authorization of Seller. Requests to return material must be received by Josam Company within 60 days of date of original shipment made by Josam Company. Buyer must return material within 30 days from the date of Seller's written authorization. Credit will be issued to the Buyer's account toward purchase of additional material only. Obsolete, discontinued or specially produced items will not be accepted for return and credit.

Where return results from causes involving Buyer's responsibility, credit for saleable goods returned will be issued at invoice price less a 25% restocking charge for handling and inspection. Return of less than \$100.00 net price will not be allowed. For other than saleable goods returned, any necessary charges to render the returned material saleable will be added. Galvanized material will be credited at the same value as painted cast iron. Chrome plated material will be credited at the value of satin finish bronze. We will issue credit for returned parts only originally ordered as a part. On all returns, incoming and outgoing freight charges to and from Michigan City, Indiana, will be deducted from any credit allowed.

### WARRANTY:

Our products are warranted to be free of defects in material and workmanship for a period of one year from date of shipment, but our liability shall be limited solely to those defects, which our inspection finds to be due to our fault. Notification of a claim for defective material or workmanship must be given in writing to Josam Company. **WE SHALL NOT BE RESPONSIBLE FOR ANY LABOR CHARGES OR ANY LOSS, INJURY OR DAMAGES WHATSOEVER, INCLUDING INCIDENTAL OR CONSEQUENTIAL DAMAGES.** The sole and exclusive remedy shall be limited to the replacement or repair of the defective goods at the Seller's discretion. Before installation and use, Buyer shall determine the suitability of the product for his intended use and the Buyer assumes all risk and liability whatever in connection therewith.

Notification of a claim for material shortage or incorrect material must be given in writing to Josam Company within 15 days of shipment.

### QUOTATIONS:

Quotations are based on discount in effect at the time of quotation and will be protected on this basis for a period of 30 days from date of quotation.

### EXPORT ORDERS:

Factors which govern export orders differ from domestic orders. Please contact Josam Customer Service.

### ACCEPTANCE OF ORDERS:

All catalogs, price lists or other literature describing our products are not to be construed as offers to sell same. All orders are subject to acceptance by the general office of Seller in Michigan City, Indiana, either by shipment or by written acceptance. Your order, when shipped or accepted by us, shall constitute the complete contract between us, subject to and incorporating therein the terms and conditions herein contained, and any inconsistent provisions contained in your order shall not apply. Prices, discounts and special programs contained in any of our catalogs, price lists or other literature are subject to change without notice.

### CANCELLATION:

Orders are not subject to cancellation without our written consent. If an order is cancelled, the Buyer shall pay all costs incurred in connection with filling the order. Any items not cataloged or items not normally stocked by us and made or purchased to fill the order become the Buyer's property and must be paid for by the Buyer.

### ILLUSTRATIONS, DESCRIPTIONS AND DIMENSIONS:

All illustrations, descriptions, and detailed dimensions represent standard features and do not necessarily indicate all variations available. All weights stated in our catalogs, literature and drawings are approximate and are not guaranteed.

All designs, descriptions and dimensions are subject to change without notice, and unless Buyer specifically states otherwise on order, standard products in effect at time order is shipped will be supplied.

### RISKS:

Our responsibility ceases after the product has been delivered to the carrier in good order. It is the responsibility of the consignee to inspect each shipment carefully and file a claim with the carrier for any damage or shortage. Content shortages must be reported within 15 days after receipt of material.

### DELIVERY:

Shipping dates are estimates and time of delivery is not the essence of this sale or the contract therefor. We will ship as near schedule as possible. Under no circumstances will the Seller have any responsibility on account of any delays in manufacture, transportation, or otherwise. Material is subject to shipment in whole or in part, at our option, and each shipment is subject to immediate invoicing.

### TAXES:

Any sales, or manufacturers' tax imposed under existing or future statutes shall be added to the price herewith effective and shall be paid by the Buyer unless proper exemption certificates are filed with Josam Company.



**11001**  
**11007**

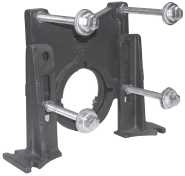

CLOSET CARRIERS	
LIST PRICE	
<b>SERIES NO.</b>	
11001 w/ 4" Pipe Grip Adapter	\$1,083.00
11007 w/ 3" Copper Ftg. Adapter	1,149.00
<b>ADD FOR OPTIONS:</b>	
-35* .....	\$793.00
*Not Available on 11007.	

**12673**  
**12674**



3" HORIZONTAL NO-HUB ADJUSTABLE			
LIST PRICE			
3" Pipe Connections			
<b>SERIES NO.</b>	<b>12673</b>	<b>12683</b>	<b>12693</b>
	Single L.H.	Single R.H.	Back-to-Back
No-Hub	\$2,051.00	\$2,051.00	\$3,804.00

**12683**  
**12684**



4" HORIZONTAL NO-HUB ADJUSTABLE			
LIST PRICE			
4" Pipe Connections			
<b>SERIES NO.</b>	<b>12674</b>	<b>12684</b>	<b>12694</b>
	Single L.H.	Single R.H.	Back-to-Back
No-Hub	\$2,276.00	\$2,276.00	\$4,250.00
-HS	2,276.00	2,276.00	4,250.00
-58	3,071.00	3,071.00	5,045.00
-HS-58	3,071.00	3,071.00	5,045.00

**12693**  
**12694**

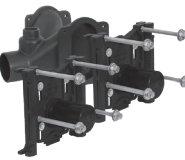

<b>ADD FOR OPTIONS:</b>			
-1* .....	\$116.00	-HS† .....	\$0.00
-6* .....	122.00	-OR .....	0.00
-6CU* .....	122.00	-PAC .....	0.00
-10 .....	0.00	-PAF .....	0.00
-24* .....	Deduct 223.00	-PF .....	0.00
-30 .....	0.00	-PFG .....	0.00
-30-2 .....	0.00	-PS .....	0.00
-32* .....	689.00	-SDH (750 LB.)* .....	764.00
-35 .....	0.00	-TB* .....	277.00
-58† .....	795.00	-VP* .....	188.00
-AUX** .....	524.00	-XSD (1000 LB.)* .....	1,044.00
-CR .....	0.00		

\*Pricing for options is per fixture. Add or subtract twice for Back-to-Back Carriers

\*\* Not Available on 12694

† Not Available on 12673, 12683, and 12693

**12704**



VERTICAL ADJUSTABLE SINGLE, NO-HUB, ON STACK			
LIST PRICE			
<b>SERIES NO.</b>	<b>No-Hub</b>	<b>-HS</b>	
12704 L.Hand 2" Vent	\$2,578.00	\$2,690.00	
12714 R.Hand 2" Vent	2,578.00	2,690.00	
<b>ADD FOR OPTIONS:</b>			
-1 .....	\$116.00	-HD4 .....	\$880.00
-6 .....	122.00	-HLH4 .....	440.00
-6CU .....	122.00	-HRH4 .....	440.00
-10 .....	0.00	-HS .....	112.00
-24 .....	Deduct 225.00	-LH4 .....	440.00
-30 .....	0.00	-OR .....	0.00
-30-2 .....	0.00	-PAC .....	0.00
-32 .....	689.00	-PAF .....	0.00
-35 .....	0.00	-PF .....	0.00
-49 .....	524.00	-PFG .....	0.00
-50 .....	524.00	-PS .....	0.00
-53 .....	524.00	-RH4 .....	440.00
-54 .....	524.00	-SDH (750 lb.) .....	764.00
-58 .....	795.00	-TB .....	277.00
-CR .....	0.00	-VP .....	188.00
-D4 .....	880.00	-XSD (1000 lb.) .....	1,044.00

**12714**



**12724**



VERTICAL ADJUSTABLE BACK-TO-BACK, NO-HUB, ON STACK			
LIST PRICE			
<b>SERIES NO.</b>	<b>No-Hub</b>	<b>-HS</b>	
12724 Back-to-Back 2" Vent	\$4,556.00	\$4,667.00	
<b>ADD FOR OPTIONS:</b>			
-1 .....	\$228.00	-HS .....	\$112.00
-6 .....	245.00	-HD4 .....	880.00
-6CU .....	245.00	-HVS4 .....	440.00
-10 .....	0.00	-OR .....	0.00
-24 .....	Deduct 446.00	-OS4 .....	440.00
-30 .....	0.00	-PAC .....	0.00
-30-2 .....	0.00	-PAF .....	0.00
-32 .....	1,381.00	-PF .....	0.00
-35 .....	0.00	-PFG .....	0.00
-49 .....	524.00	-PS .....	0.00
-50 .....	524.00	-SDH (750 LB.) .....	1,528.00
-53 .....	524.00	-TB .....	554.00
-54 .....	524.00	-VP .....	377.00
-58 .....	795.00	-VS4 .....	440.00
-CR .....	0.00	-XSD (1000 lb.) .....	2,086.00
-D4 .....	880.00		

**14004**



















VERTICAL CLOSE HUB & SPIGOT, OFFSET	
LIST PRICE	
<b>SERIES NO.</b>	
14004 Sgl. L.H., L.H. 2" Vent	\$2,044.00
14024 Sgl. R.H., R.H. 2" Vent	2,044.00
14044 Back-to-Back, 2" Vent	3,499.00
<b>ADD FOR OPTIONS:</b>	
-1* .....	\$116.00
-6* .....	122.00
-6CU* .....	122.00
-21* .....	469.00
-54 .....	\$524.00
-VP* .....	188.00
-XSD (1000 lb.)* .....	1,044.00

\* Pricing for options is per fixture. Add or subtract twice for Back-to-Back Carriers

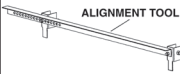
**Option Descriptions**

-AUX	Auxiliary Inlet, 2"	-1	Positioning Frame
-CR	Compression Ring Carrier	-6	Supply Pipe Support - Galvanized Pipe
-D4	Double 4" No-Hub Branches	-6CU	Supply Pipe Support - Copper Pipe
-HD4	Double 4" Hub Branches	-10	ABS Extension through 10-1/2" Wall
-HLH4	Left-Hand 4" Hub Branch	-21	Hanger Type Closet Adapter
-HRH4	Right-Hand 4" Hub Branch	-24	Carrier for Floor-Mounted, Back-Outlet China Bowls
-HS	Hub & Spigot	-30	Cast Iron Adjustable Extension with Connector
-HVS4	Vent Side 4" Hub Branch	-30-2	Cast Iron Adjustable Extension with Connector and Test Cap
-6CU	Supply Pipe Support - Copper	-32	Carrier for Wide Chase Installations
-LH4	Left-Hand 4" No-Hub Branch	-35	Closet Carrier for Wheelchair High Rough
-OR	O-Ring Carrier	-49	No-Hub High Auxiliary Inlet, Under Vent
-OS4	Opposite Vent 4" No-Hub Branch	-50	No-Hub High Auxiliary Inlet, Opposite Vent
-PAC	Pre-Assembled Carrier	-53	Threaded High Auxiliary Inlet, Under Vent
-PAF	Prefab Adjustable Foot	-54	Threaded High Auxiliary Inlet, Opposite Vent
-PF	Pylon Foot, Standard	-58	Horizontal No-Hub Cast Long Barrel
-PFG	Alternate Prefab Faceplate Gasket (Standard with PAF)		
-PS	Foam Sleeve for Extension		
-RH4	Right-Hand 4" No-Hub Branch		
-SDH	Special-Duty 750 lb. Carrier		
-TB	Test Bracket		
-VP	Vandal-Proof Trim		
-VS4	Vent Side 4" No-Hub Branch		
-XSD	Extra Special-Duty 1,000 lb. Carrier		

<p><b>14064</b></p>  <p><b>14104</b></p> 	<p style="text-align: center;"><b>VERTICAL CLOSE HUB &amp; SPIGOT, ON STACK</b></p> <p style="text-align: center;"><b>LIST PRICE</b></p> <table border="1"> <thead> <tr> <th colspan="2">SERIES NO.</th> </tr> </thead> <tbody> <tr> <td>14064 Sgl., 4" Vent</td> <td>\$2,044.00</td> </tr> <tr> <td>14104 Sgl., 2" Vent</td> <td>2,044.00</td> </tr> </tbody> </table> <p><b>ADD FOR OPTIONS:</b></p> <table border="1"> <tbody> <tr> <td>-1 .....</td> <td>\$116.00</td> <td>-SDH (750 lb.) .....</td> <td>764.00</td> </tr> <tr> <td>-6 .....</td> <td>122.00</td> <td>-XSD (1000 lb.) .....</td> <td>1,044.00</td> </tr> <tr> <td>-6CU .....</td> <td>122.00</td> <td>-VP .....</td> <td>188.00</td> </tr> <tr> <td>-45 .....</td> <td>524.00</td> <td></td> <td></td> </tr> <tr> <td>-46 .....</td> <td>524.00</td> <td></td> <td></td> </tr> </tbody> </table>	SERIES NO.		14064 Sgl., 4" Vent	\$2,044.00	14104 Sgl., 2" Vent	2,044.00	-1 .....	\$116.00	-SDH (750 lb.) .....	764.00	-6 .....	122.00	-XSD (1000 lb.) .....	1,044.00	-6CU .....	122.00	-VP .....	188.00	-45 .....	524.00			-46 .....	524.00			<p><b>15964</b></p>  <p style="text-align: center;"><b>90° INSTITUTIONAL FITTING VERTICAL NO-HUB, ON STACK</b></p> <p style="text-align: center;"><b>LIST PRICE</b></p> <table border="1"> <thead> <tr> <th colspan="2">SERIES NO.</th> </tr> </thead> <tbody> <tr> <td>15964 Double Waste Fitting with Vent and Carriers</td> <td>\$6,191.00</td> </tr> </tbody> </table> <p><b>ADD FOR OPTIONS:</b></p> <table border="1"> <tbody> <tr> <td>-1 .....</td> <td>\$228.00</td> <td>-30-2 .....</td> <td>\$0.00</td> </tr> <tr> <td>-6 .....</td> <td>245.00</td> <td>-49 .....</td> <td>524.00</td> </tr> <tr> <td>-6CU .....</td> <td>245.00</td> <td>-54 .....</td> <td>524.00</td> </tr> <tr> <td>-10 .....</td> <td>0.00</td> <td>-VP .....</td> <td>377.00</td> </tr> <tr> <td>-24 .....</td> <td>Deduct 225.00</td> <td>-XSD (1000 lb.) .....</td> <td>2,086.00</td> </tr> <tr> <td>-26 .....</td> <td>0.00</td> <td></td> <td></td> </tr> <tr> <td>-30 .....</td> <td>0.00</td> <td></td> <td></td> </tr> </tbody> </table>	SERIES NO.		15964 Double Waste Fitting with Vent and Carriers	\$6,191.00	-1 .....	\$228.00	-30-2 .....	\$0.00	-6 .....	245.00	-49 .....	524.00	-6CU .....	245.00	-54 .....	524.00	-10 .....	0.00	-VP .....	377.00	-24 .....	Deduct 225.00	-XSD (1000 lb.) .....	2,086.00	-26 .....	0.00			-30 .....	0.00		
SERIES NO.																																																												
14064 Sgl., 4" Vent	\$2,044.00																																																											
14104 Sgl., 2" Vent	2,044.00																																																											
-1 .....	\$116.00	-SDH (750 lb.) .....	764.00																																																									
-6 .....	122.00	-XSD (1000 lb.) .....	1,044.00																																																									
-6CU .....	122.00	-VP .....	188.00																																																									
-45 .....	524.00																																																											
-46 .....	524.00																																																											
SERIES NO.																																																												
15964 Double Waste Fitting with Vent and Carriers	\$6,191.00																																																											
-1 .....	\$228.00	-30-2 .....	\$0.00																																																									
-6 .....	245.00	-49 .....	524.00																																																									
-6CU .....	245.00	-54 .....	524.00																																																									
-10 .....	0.00	-VP .....	377.00																																																									
-24 .....	Deduct 225.00	-XSD (1000 lb.) .....	2,086.00																																																									
-26 .....	0.00																																																											
-30 .....	0.00																																																											
<p><b>14404</b></p>  <p><b>14424</b> (R.H. Not Shown)</p> <p><b>14444</b></p> 	<p style="text-align: center;"><b>VERTICAL CLOSE NO-HUB, OFFSET</b></p> <p style="text-align: center;"><b>LIST PRICE</b></p> <table border="1"> <thead> <tr> <th colspan="2">SERIES NO.</th> </tr> </thead> <tbody> <tr> <td>14404 Sgl. L.H., L.H. 2" Vent</td> <td>\$2,044.00</td> </tr> <tr> <td>14424 Sgl. R.H., R.H. 2" Vent</td> <td>2,044.00</td> </tr> <tr> <td>14444 Back-to-Back, 2" Vent</td> <td>3,499.00</td> </tr> </tbody> </table> <p><b>ADD FOR OPTIONS:</b></p> <table border="1"> <tbody> <tr> <td>-1* .....</td> <td>\$116.00</td> <td>-30-2 .....</td> <td>\$0.00</td> </tr> <tr> <td>-6* .....</td> <td>122.00</td> <td>-50 .....</td> <td>524.00</td> </tr> <tr> <td>-6CU* .....</td> <td>122.00</td> <td>-54 .....</td> <td>524.00</td> </tr> <tr> <td>-10 .....</td> <td>0.00</td> <td>-SDH (750 lb.) .....</td> <td>764.00</td> </tr> <tr> <td>-24* .....</td> <td>Deduct 225.00</td> <td>-XSD (1000 lb.) .....</td> <td>1,044.00</td> </tr> <tr> <td>-30 .....</td> <td>0.00</td> <td>-VP* .....</td> <td>188.00</td> </tr> </tbody> </table> <p>* Pricing for options is per fixture. Add or subtract twice for Back-to-Back Carriers</p>	SERIES NO.		14404 Sgl. L.H., L.H. 2" Vent	\$2,044.00	14424 Sgl. R.H., R.H. 2" Vent	2,044.00	14444 Back-to-Back, 2" Vent	3,499.00	-1* .....	\$116.00	-30-2 .....	\$0.00	-6* .....	122.00	-50 .....	524.00	-6CU* .....	122.00	-54 .....	524.00	-10 .....	0.00	-SDH (750 lb.) .....	764.00	-24* .....	Deduct 225.00	-XSD (1000 lb.) .....	1,044.00	-30 .....	0.00	-VP* .....	188.00	<p><b>15984</b></p>  <p style="text-align: center;"><b>90° INSTITUTIONAL FITTING VERTICAL NO-HUB, ON STACK</b></p> <p style="text-align: center;"><b>LIST PRICE</b></p> <table border="1"> <thead> <tr> <th colspan="2">SERIES NO.</th> </tr> </thead> <tbody> <tr> <td>15984 Double Waste Fitting, No-Hub Branches, 2" Vent</td> <td>\$2,356.00</td> </tr> </tbody> </table> <p><b>ADD FOR OPTIONS:</b></p> <table border="1"> <tbody> <tr> <td>-26 .....</td> <td>\$0.00</td> <td>-54 .....</td> <td>\$524.00</td> </tr> <tr> <td>-49 .....</td> <td>524.00</td> <td></td> <td></td> </tr> </tbody> </table>	SERIES NO.		15984 Double Waste Fitting, No-Hub Branches, 2" Vent	\$2,356.00	-26 .....	\$0.00	-54 .....	\$524.00	-49 .....	524.00																
SERIES NO.																																																												
14404 Sgl. L.H., L.H. 2" Vent	\$2,044.00																																																											
14424 Sgl. R.H., R.H. 2" Vent	2,044.00																																																											
14444 Back-to-Back, 2" Vent	3,499.00																																																											
-1* .....	\$116.00	-30-2 .....	\$0.00																																																									
-6* .....	122.00	-50 .....	524.00																																																									
-6CU* .....	122.00	-54 .....	524.00																																																									
-10 .....	0.00	-SDH (750 lb.) .....	764.00																																																									
-24* .....	Deduct 225.00	-XSD (1000 lb.) .....	1,044.00																																																									
-30 .....	0.00	-VP* .....	188.00																																																									
SERIES NO.																																																												
15984 Double Waste Fitting, No-Hub Branches, 2" Vent	\$2,356.00																																																											
-26 .....	\$0.00	-54 .....	\$524.00																																																									
-49 .....	524.00																																																											
<p><b>14464</b></p>  <p><b>14484</b></p> 	<p style="text-align: center;"><b>VERTICAL CLOSE NO-HUB, ON STACK</b></p> <p style="text-align: center;"><b>LIST PRICE</b></p> <table border="1"> <thead> <tr> <th colspan="2">SERIES NO.</th> </tr> </thead> <tbody> <tr> <td>14464 Single, 4" Vent</td> <td>\$2,044.00</td> </tr> <tr> <td>14484 Back-to-Back, 4" Vent Siphon Jet Closets Only</td> <td>3,614.00</td> </tr> </tbody> </table> <p><b>ADD FOR OPTIONS:</b></p> <table border="1"> <tbody> <tr> <td>-1* .....</td> <td>\$116.00</td> <td>-45 .....</td> <td>\$524.00</td> </tr> <tr> <td>-6* .....</td> <td>122.00</td> <td>-46 .....</td> <td>524.00</td> </tr> <tr> <td>-6CU* .....</td> <td>122.00</td> <td>-SDH (750 lb.) .....</td> <td>764.00</td> </tr> <tr> <td>-10 .....</td> <td>0.00</td> <td>-VP* .....</td> <td>188.00</td> </tr> <tr> <td>-24* .....</td> <td>Deduct 225.00</td> <td>-XSD (1000 lb.) .....</td> <td>1,044.00</td> </tr> <tr> <td>-30 .....</td> <td>0.00</td> <td></td> <td></td> </tr> <tr> <td>-30-2 .....</td> <td>0.00</td> <td></td> <td></td> </tr> </tbody> </table> <p>* Pricing for options is per fixture. Add or subtract twice for Back-to-Back Carriers</p>	SERIES NO.		14464 Single, 4" Vent	\$2,044.00	14484 Back-to-Back, 4" Vent Siphon Jet Closets Only	3,614.00	-1* .....	\$116.00	-45 .....	\$524.00	-6* .....	122.00	-46 .....	524.00	-6CU* .....	122.00	-SDH (750 lb.) .....	764.00	-10 .....	0.00	-VP* .....	188.00	-24* .....	Deduct 225.00	-XSD (1000 lb.) .....	1,044.00	-30 .....	0.00			-30-2 .....	0.00			<p style="text-align: center;"><b>16123</b></p>  <p style="text-align: center;"><b>FLOOR-MOUNT PVC ADAPTER TYPE, ON STACK</b></p> <p style="text-align: center;"><b>LIST PRICE</b></p> <table border="1"> <thead> <tr> <th colspan="2">SERIES NO.</th> </tr> </thead> <tbody> <tr> <td>16123 Single, for PVC Pipe Siphon Jet Closets Only</td> <td>\$1,472.00</td> </tr> </tbody> </table> <p><b>ADD FOR OPTIONS:</b></p> <table border="1"> <tbody> <tr> <td>-1 .....</td> <td>\$116.00</td> <td>-13 .....</td> <td>\$0.00</td> </tr> <tr> <td>-6 .....</td> <td>122.00</td> <td>-21 .....</td> <td>469.00</td> </tr> <tr> <td></td> <td></td> <td>-VP .....</td> <td>188.00</td> </tr> </tbody> </table>	SERIES NO.		16123 Single, for PVC Pipe Siphon Jet Closets Only	\$1,472.00	-1 .....	\$116.00	-13 .....	\$0.00	-6 .....	122.00	-21 .....	469.00			-VP .....	188.00								
SERIES NO.																																																												
14464 Single, 4" Vent	\$2,044.00																																																											
14484 Back-to-Back, 4" Vent Siphon Jet Closets Only	3,614.00																																																											
-1* .....	\$116.00	-45 .....	\$524.00																																																									
-6* .....	122.00	-46 .....	524.00																																																									
-6CU* .....	122.00	-SDH (750 lb.) .....	764.00																																																									
-10 .....	0.00	-VP* .....	188.00																																																									
-24* .....	Deduct 225.00	-XSD (1000 lb.) .....	1,044.00																																																									
-30 .....	0.00																																																											
-30-2 .....	0.00																																																											
SERIES NO.																																																												
16123 Single, for PVC Pipe Siphon Jet Closets Only	\$1,472.00																																																											
-1 .....	\$116.00	-13 .....	\$0.00																																																									
-6 .....	122.00	-21 .....	469.00																																																									
		-VP .....	188.00																																																									
<p><b>14504</b></p> 	<p style="text-align: center;"><b>VERTICAL CLOSE NO-HUB, ON STACK</b></p> <p style="text-align: center;"><b>LIST PRICE</b></p> <table border="1"> <thead> <tr> <th colspan="2">SERIES NO.</th> </tr> </thead> <tbody> <tr> <td>14504 Single, 2" Vent</td> <td>\$2,044.00</td> </tr> </tbody> </table> <p><b>ADD FOR OPTIONS:</b></p> <table border="1"> <tbody> <tr> <td>-1 .....</td> <td>\$116.00</td> <td>-45 .....</td> <td>\$524.00</td> </tr> <tr> <td>-6 .....</td> <td>122.00</td> <td>-46 .....</td> <td>524.00</td> </tr> <tr> <td>-6CU .....</td> <td>122.00</td> <td>-SDH (750 lb.) .....</td> <td>764.00</td> </tr> <tr> <td>-10 .....</td> <td>0.00</td> <td>-VP .....</td> <td>188.00</td> </tr> <tr> <td>-24 .....</td> <td>Deduct 225.00</td> <td>-XSD (1000 lb.) .....</td> <td>1,044.00</td> </tr> <tr> <td>-30 .....</td> <td>0.00</td> <td></td> <td></td> </tr> <tr> <td>-30-2 .....</td> <td>0.00</td> <td></td> <td></td> </tr> </tbody> </table>	SERIES NO.		14504 Single, 2" Vent	\$2,044.00	-1 .....	\$116.00	-45 .....	\$524.00	-6 .....	122.00	-46 .....	524.00	-6CU .....	122.00	-SDH (750 lb.) .....	764.00	-10 .....	0.00	-VP .....	188.00	-24 .....	Deduct 225.00	-XSD (1000 lb.) .....	1,044.00	-30 .....	0.00			-30-2 .....	0.00			<p style="text-align: center;"><b>Closet Carrier Option Descriptions</b></p> <ul style="list-style-type: none"> <li>-SDH Special-Duty 750 lb. Carrier</li> <li>-XSD Extra Special-Duty 1,000 lb. Carrier</li> <li>-VP Vandal-Proof Trim</li> <li>-1 Positioning Frame</li> <li>-6 Supply Pipe Support - Galvanized Pipe</li> <li>-6CU Supply Pipe Support - Copper Pipe</li> <li>-10 ABS Extension through 10-1/2" Wall</li> <li>-13 3" ABS Fitting Adapter</li> <li>-21 Hanger Type Closet Adapter</li> <li>-24 Carrier for Floor-Mounted, Back-Outlet China Bowls</li> <li>-26 Fitting Anchor Foot</li> <li>-30 Cast Iron Adjustable Extension with Connector</li> <li>-30-2 Cast Iron Adjustable Extension with Connector and Test Cap</li> <li>-45 Threaded Left-Hand Auxiliary Inlet</li> <li>-46 Threaded Right-Hand Auxiliary Inlet</li> <li>-49 No-Hub High Auxiliary Inlet, Under Vent</li> <li>-50 No-Hub High Auxiliary Inlet, Opposite Vent</li> <li>-54 Threaded High Auxiliary Inlet, Opposite Vent</li> </ul>																										
SERIES NO.																																																												
14504 Single, 2" Vent	\$2,044.00																																																											
-1 .....	\$116.00	-45 .....	\$524.00																																																									
-6 .....	122.00	-46 .....	524.00																																																									
-6CU .....	122.00	-SDH (750 lb.) .....	764.00																																																									
-10 .....	0.00	-VP .....	188.00																																																									
-24 .....	Deduct 225.00	-XSD (1000 lb.) .....	1,044.00																																																									
-30 .....	0.00																																																											
-30-2 .....	0.00																																																											

	<b>17000 REUSABLE ALIGNMENT TOOL</b>			
	<b>LIST PRICE</b>			
TYPE NO.		17000	\$384.00	
	<b>17100 FLOOR-MOUNT ADJUSTABLE CONCEALED ARMS</b>			
	<b>LIST PRICE</b>			
	TYPE NO.		17100	17100-BB
			\$1,415.00	\$2,018.00
	<b>ADD FOR OPTIONS:</b>			
	17100		17100-BB	
	-10*	\$67.00	\$138.00	
	-60	211.00	419.00	
	-67	95.00	192.00	
	-75	233.00	464.00	
	-76	423.00	847.00	
	-77	423.00	847.00	
-BB	602.00	ABOVE		
-S**	----	0.00		
-T**	----	137.00		
-U**	----	274.00		
-V**	----	413.00		
-W**	----	550.00		
-X**	----	687.00		
-Y**	----	825.00		
-Z**	----	964.00		
<small>*Extension Sleeves Longer than 6-1/2", Specify Wall Thickness, Price Per Inch</small>				
<small>**Wall Thickness (inches) Suffix Wall Thickness (inches) Suffix</small>				
4-1/2 to 5		S	8-1/16 to 9 W	
5-1/16 to 6		T	9-1/16 to 10 X	
6-1/16 to 7		U	10-1/16 to 11 Y	
7-1/16 to 8		V	11-1/16 to 12 Z	
	<b>17120 WALL-MOUNT ADJUSTABLE CONCEALED ARMS</b>			
	<b>LIST PRICE</b>			
TYPE NO.		17120	\$837.00	
<b>ADD FOR OPTIONS:</b>				
-10*	\$67.00	-77	\$423.00	
-67	95.00	-BP	0.00	
-75	233.00	-MMB	Deduct 175.00	
-76	423.00			
<small>* Extension Sleeves Longer than 4", Specify Wall Thickness, Price Per Inch</small>				
	<b>17125 WALL-MOUNT, NON-ADJUSTABLE CONCEALED ARMS</b>			
	<b>LIST PRICE</b>			
TYPE NO.		17125	\$652.00	
<b>ADD FOR OPTIONS:</b>				
-10*	\$67.00	-75	\$233.00	
<small>* Extension Sleeves Longer than 4", Specify Wall Thickness, Price Per Inch</small>				
	<b>17125-UP-ADJ PRE-ASSEMBLED CARRIER, FLOOR-MOUNT ADJUSTABLE CONCEALED ARMS</b>			
	<b>LIST PRICE</b>			
TYPE NO.		17125-UP-ADJ	\$1,846.00	
<b>ADD FOR OPTIONS:</b>				
-10*	\$67.00	-75	\$233.00	
<small>* Extension Sleeves Longer than 4", Specify Wall Thickness, Price Per Inch</small>				
	<b>17140 NON-ADJUSTABLE, CONCEALED ARMS w/WELDED SLEEVES FOR BLOCK WALL MOUNT</b>			
	<b>LIST PRICE</b>			
TYPE NO.		17140	\$658.00	
<b>ADD FOR OPTIONS:</b>				
-75	\$233.00			

	<b>17380 FLOOR-MOUNT ADJUSTABLE EXPOSED ARMS</b>		
	<b>LIST PRICE</b>		
TYPE NO.		17380	17380-BB
		\$2,021.00	\$3,171.00
<b>ADD FOR OPTIONS:</b>			
17380		17380-BB	
-10*	\$67.00	\$138.00	
-60	211.00	419.00	
-66**	Deduct 192.00	----	
-BB**	1,150.00	ABOVE	
-HD	239.00	478.00	
-VP	188.00	377.00	
<small>* Hardware for Walls over 4-1/2", Specify Wall Thickness, Price Per Inch</small>			
<small>** -66 cannot be Furnished with -BB.</small>			

	<b>17390 WALL-MOUNT ADJUSTABLE EXPOSED ARMS</b>		
	<b>LIST PRICE</b>		
TYPE NO.		17390	\$1,405.00
<b>ADD FOR OPTIONS:</b>			
-10*	\$67.00	-BP	\$0.00
		-VP	\$188.00
<small>* Hardware for Walls over 4-1/2", Specify Wall Thickness, Price Per Inch</small>			

	<b>17405 WALL-MOUNT EXPOSED ARMS ONLY</b>		
	<b>LIST PRICE</b>		
TYPE NO.		17405	\$907.00
<b>ADD FOR OPTIONS:</b>			
-10*	\$67.00	-7VP	\$188.00
<small>* Hardware for Walls over 4-1/2", Specify Wall Thickness, Price Per Inch</small>			

	<b>17550 FLOOR-MOUNT HANGER PLATE TYPE</b>			
	<b>LIST PRICE</b>			
17550	17550-BB	17550-UR	17550-WC	17550-WCBL
\$1,072.00	\$1,415.00	\$1,072.00	\$1,756.00	
<b>ADD FOR OPTIONS:</b>			17550 17550-BB	
-10*	\$67.00	\$138.00		
-60	211.00	419.00		
-BB	345.00	ABOVE		
-CL	441.00	----		
-UR**	0.00	----		
-WC**	0.00	----		
-WCBL**	684.00	----		
<small>* Hardware for Walls over 4", Specify Wall Thickness, Price Per Inch</small>				
<small>** Cannot be Furnished with -60</small>				

### Fixture Carrier Option Descriptions

-BB	Back-to-Back Carrier	-60	Valve Plate for Attaching to Upright
-BP	with Back Plates	-66	Split Header for Stainless Steel Arms
-CL	Corner Lavatory Carrier	-67	Concealed Arm Carrier for Wheelchair Lavatory
-HD	Heavy-Duty	-75	2" Chrome Plated Escutcheons
-MMB	with Movable Mounting Brackets	-76	4" Chrome Plated Escutcheons
-UR	Urinal Carrier	-77	6" Chrome Plated Escutcheons
-VP	Vandal-Proof Trim	-58	Horizontal No-Hub Cast Long Barrel
-WC	Water Cooler Carrier		
-WCBL	Water Cooler Bi-Level Carrier		
-10	Extension Sleeves or Hardware for Thicker Walls, See Product No-Hub Branch		



**17560**



**FLOOR-MOUNT BEARING PLATE TYPE**

LIST PRICE			
17560	17560-BB	17560-UR 17560-WC	17560- WCBL
\$1,195.00	\$1,670.00	1,195.00	\$1,877.00

**ADD FOR OPTIONS:**

	17560	17560-BB
-10*	\$67.00	\$138.00
-60	211.00	419.00
-BB	476.00	ABOVE
-UR**	0.00	-----
-WC**	0.00	-----
-WCBL**	684.00	-----

\* Hardware for Walls over 4", Specify Wall Thickness, Price Per Inch

\*\* Cannot be Furnished with -60

**17590**



**WALL-MOUNT HANGER PLATE TYPE**

LIST PRICE		
17590	17590-DP	17590-UR
\$296.00	\$364.00	\$296.00

**ADD FOR OPTIONS:**

-10* .....	\$67.00	-DP .....	\$67.00
		-UR .....	0.00

\* Hardware for Walls over 7" for 17590 or 4" for 17590-DP and 17590-UR-DP; Specify Wall Thickness, Price Per Inch

**17720**



**FLOOR-MOUNT HEAVY-DUTY PLATE TYPE**

LIST PRICE		
TYPE NO.	17720	\$3,639.00

**ADD FOR OPTIONS:**

-10* .....	\$142.00	-VP .....	\$188.00
-66 .....	Ded. 211.00		

\* Hardware for Walls over 4", Specify Wall Thickness, Price Per Inch

**17730**



**FLOOR-MOUNT w/ADJUSTABLE COUPLING**

LIST PRICE		
TYPE NO.	17730	\$1,713.00

**ADD FOR OPTIONS:**

-11 .....	\$0.00	-VP .....	\$188.00
-60 .....	211.00		

**17735**



**FLOOR-MOUNT w/FITTING**

LIST PRICE		
TYPE NO.	17735	\$2,838.00

**ADD FOR OPTIONS:**

-10 .....	\$0.00	-60 .....	\$211.00
-45 .....	524.00	-VP .....	188.00
-46 .....	524.00		

\* Hardware for Walls over 5-3/8", Specify Wall Thickness, Price Per Inch

NOTE: Other Fittings Available on Request. Contact your Josam Representative.

- Fixture Carrier Option Descriptions**
- BB Back-to-Back Carrier
  - DP Double Plate Carrier
  - UR Urinal Carrier
  - VP Vandal-Proof Trim
  - WC Water Cooler Carrier
  - WCBL Water Cooler Bi-Level Carrier
  - 10 Hardware for Thicker Walls
  - 11 Cast Iron Adjustable Extension through 12" Length, Specify 6", 9" or 12" on Order
  - 45 Threaded High Left-Hand Auxiliary Vent
  - 46 Threaded High Right-Hand Auxiliary Vent
  - 60 Valve Plate for Attaching to Upright
  - 66 Split Header for Stainless Steel Arms

**ROOF DRAINS**

**21500**



**15" DOME, LARGE SUMP**

PIPE SIZE	LIST PRICE			
	21500	21500-AE	21500-16	21500-AE-16
2", 3", 4"	1,016.00	\$2,033.00	\$1,619.00	\$2,636.00
5", 6"	1,452.00	2,469.00	2,055.00	3,070.00
8"	1,884.00	2,900.00	2,486.00	N/A
10"	2,973.00	3,989.00	N/A	N/A

**ADD FOR OPTIONS:**

-1 .....	\$348.00	-19 .....	\$1,127.00	-IRMA .....	\$1,127.00
-2 .....	392.00	-20 .....	1,374.00	-CR .....	601.00
-3 .....	736.00	-21-22 .....	891.00	-FG .....	987.00
-3C .....	528.00	-22 .....	299.00	-FG2 .....	1,182.00
-4 .....	268.00	-23 .....	1,191.00	-FG3 .....	1,596.00
-6 .....	1,891.00	-26 .....	351.00	-OR .....	1,016.00
-10* .....	949.00	-33 .....	719.00	-T .....	112.00
-10-20* .....	1,504.00	-66 .....	530.00	-VP .....	177.00
-16 ◊ .....	603.00	-AE .....	1,016.00	-X .....	0.00
-17 ◊ .....	329.00	-AER .....	466.00	-Y .....	0.00
		-ARE .....	1,952.00	-Z .....	0.00

\* Specify Height, Price Each 4" or Fraction

◊ -16 and -17 cannot be furnished together

**GREEN ROOF DRAINS**

**21500-RDG**

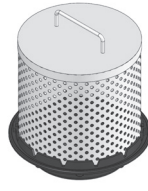







PIPE SIZE	LIST PRICE			
	21500-RDG1	21500-RDG2	21500-RDG3	21500-ORDG1
2", 3", 4"	\$5,531.00	\$5,216.00	\$5,366.00	\$5,531.00
5", 6"	5,963.00	5,648.00	5,802.00	5,963.00
8"	6,398.00	6,084.00	6,233.00	6,396.00

**ADD FOR OPTIONS:**

-1 .....	\$348.00	-21 .....	\$591.00	-CR .....	\$601.00
-2 .....	392.00	-22 .....	299.00	-OR .....	1,016.00
-3 .....	736.00	-23 .....	1,191.00	-PC .....	0.00
-3C .....	528.00	-26 .....	351.00	-T .....	112.00
-4 .....	268.00	-33 .....	719.00	-VP .....	177.00
-6 .....	1,891.00	-66 .....	530.00	-X .....	0.00
-10* .....	949.00	-AE .....	1,016.00	-Y .....	0.00
-10-20* .....	1,504.00	-AER .....	466.00	-Z .....	0.00
-17 .....	329.00	-AI .....	1,282.00		
-20 .....	1,374.00	-ARE .....	1,952.00		











\* Specify Height, Price Each 4" or Fraction

	<b>22010 12" BEEHIVE DOME, MEDIUM SUMP</b>																																																																																						
	<table border="1"> <thead> <tr> <th colspan="4">LIST PRICE</th> </tr> <tr> <th>PIPE SIZE</th> <th colspan="2">2" - 6"</th> <th>\$899.00</th> </tr> </thead> <tbody> <tr> <td colspan="4"><b>ADD FOR OPTIONS:</b></td> </tr> <tr> <td>-1 .....</td> <td>\$213.00</td> <td>-19 .....</td> <td>\$899.00 -ARE...\$1,527.00</td> </tr> <tr> <td>-2 .....</td> <td>369.00</td> <td>-20 .....</td> <td>560.00 -FG.....495.00</td> </tr> <tr> <td>-3 .....</td> <td>583.00</td> <td>-21 .....</td> <td>227.00 -IRMA†...666.00</td> </tr> <tr> <td>-3C.....</td> <td>508.00</td> <td>-23 .....</td> <td>583.00 -T.....112.00</td> </tr> <tr> <td>-10*.....</td> <td>126.00</td> <td>-26 .....</td> <td>258.00 -VP.....163.00</td> </tr> <tr> <td>-10-20*..</td> <td>249.00</td> <td>-66 .....</td> <td>227.00 -X.....0.00</td> </tr> <tr> <td>-17 .....</td> <td>270.00</td> <td>-AER.....</td> <td>725.00 -Z.....0.00</td> </tr> </tbody> </table> <p>* Specify Height, Price Per Inch † Price up to 4". Each additional inch, add \$110.00.</p>				LIST PRICE				PIPE SIZE	2" - 6"		\$899.00	<b>ADD FOR OPTIONS:</b>				-1 .....	\$213.00	-19 .....	\$899.00 -ARE...\$1,527.00	-2 .....	369.00	-20 .....	560.00 -FG.....495.00	-3 .....	583.00	-21 .....	227.00 -IRMA†...666.00	-3C.....	508.00	-23 .....	583.00 -T.....112.00	-10*.....	126.00	-26 .....	258.00 -VP.....163.00	-10-20*..	249.00	-66 .....	227.00 -X.....0.00	-17 .....	270.00	-AER.....	725.00 -Z.....0.00																																											
LIST PRICE																																																																																							
PIPE SIZE	2" - 6"		\$899.00																																																																																				
<b>ADD FOR OPTIONS:</b>																																																																																							
-1 .....	\$213.00	-19 .....	\$899.00 -ARE...\$1,527.00																																																																																				
-2 .....	369.00	-20 .....	560.00 -FG.....495.00																																																																																				
-3 .....	583.00	-21 .....	227.00 -IRMA†...666.00																																																																																				
-3C.....	508.00	-23 .....	583.00 -T.....112.00																																																																																				
-10*.....	126.00	-26 .....	258.00 -VP.....163.00																																																																																				
-10-20*..	249.00	-66 .....	227.00 -X.....0.00																																																																																				
-17 .....	270.00	-AER.....	725.00 -Z.....0.00																																																																																				
	<b>22080 9" HIGH DOME, SMALL SUMP</b>																																																																																						
	<table border="1"> <thead> <tr> <th colspan="4">LIST PRICE</th> </tr> <tr> <th>PIPE SIZE</th> <th colspan="2">2", 3", 4"</th> <th>\$756.00</th> </tr> </thead> <tbody> <tr> <td colspan="4"><b>ADD FOR OPTIONS:</b></td> </tr> <tr> <td>-1 .....</td> <td>\$213.00</td> <td>-20 .....</td> <td>\$288.00 -FG.....\$423.00</td> </tr> <tr> <td>-2 .....</td> <td>369.00</td> <td>-21 .....</td> <td>114.00 -IRMA†...666.00</td> </tr> <tr> <td>-3 .....</td> <td>583.00</td> <td>-23 .....</td> <td>477.00 -T.....112.00</td> </tr> <tr> <td>-3C.....</td> <td>487.00</td> <td>-26 .....</td> <td>258.00 -TSO ◊...267.00</td> </tr> <tr> <td>-10*.....</td> <td>126.00</td> <td>-33 .....</td> <td>433.00 -VP.....163.00</td> </tr> <tr> <td>-10-20*..</td> <td>249.00</td> <td>-66 .....</td> <td>223.00 -X.....0.00</td> </tr> <tr> <td>-17 .....</td> <td>270.00</td> <td>-AER.....</td> <td>725.00 -Y.....0.00</td> </tr> <tr> <td>-19 .....</td> <td>666.00</td> <td>-ARE.....</td> <td>1,098.00 -Z.....0.00</td> </tr> </tbody> </table> <p>* Specify Height, Price Per Inch † Price up to 4". Each additional inch, add \$110.00. ◊ Cannot be used with Drain Receiver</p>				LIST PRICE				PIPE SIZE	2", 3", 4"		\$756.00	<b>ADD FOR OPTIONS:</b>				-1 .....	\$213.00	-20 .....	\$288.00 -FG.....\$423.00	-2 .....	369.00	-21 .....	114.00 -IRMA†...666.00	-3 .....	583.00	-23 .....	477.00 -T.....112.00	-3C.....	487.00	-26 .....	258.00 -TSO ◊...267.00	-10*.....	126.00	-33 .....	433.00 -VP.....163.00	-10-20*..	249.00	-66 .....	223.00 -X.....0.00	-17 .....	270.00	-AER.....	725.00 -Y.....0.00	-19 .....	666.00	-ARE.....	1,098.00 -Z.....0.00																																							
LIST PRICE																																																																																							
PIPE SIZE	2", 3", 4"		\$756.00																																																																																				
<b>ADD FOR OPTIONS:</b>																																																																																							
-1 .....	\$213.00	-20 .....	\$288.00 -FG.....\$423.00																																																																																				
-2 .....	369.00	-21 .....	114.00 -IRMA†...666.00																																																																																				
-3 .....	583.00	-23 .....	477.00 -T.....112.00																																																																																				
-3C.....	487.00	-26 .....	258.00 -TSO ◊...267.00																																																																																				
-10*.....	126.00	-33 .....	433.00 -VP.....163.00																																																																																				
-10-20*..	249.00	-66 .....	223.00 -X.....0.00																																																																																				
-17 .....	270.00	-AER.....	725.00 -Y.....0.00																																																																																				
-19 .....	666.00	-ARE.....	1,098.00 -Z.....0.00																																																																																				
	<b>22100 COMBINATION DRAIN/OVERFLOW, SMALL SUMP w/CI DOME</b>																																																																																						
	<table border="1"> <thead> <tr> <th colspan="4">LIST PRICE</th> </tr> <tr> <th>PIPE SIZE</th> <th colspan="2">3", 4"</th> <th>\$1,045.00</th> </tr> </thead> <tbody> <tr> <td colspan="4"><b>ADD FOR OPTIONS:</b></td> </tr> <tr> <td>-1 .....</td> <td>\$492.00</td> <td>-23 .....</td> <td>\$477.00 -VP.....\$324.00</td> </tr> <tr> <td>-10*.....</td> <td>249.00</td> <td>-33 .....</td> <td>806.00 -Z.....0.00</td> </tr> <tr> <td>-20 .....</td> <td>574.00</td> <td>-IRMA..</td> <td>1,325.00</td> </tr> </tbody> </table> <p>*Specify Height, Price Per Inch</p>				LIST PRICE				PIPE SIZE	3", 4"		\$1,045.00	<b>ADD FOR OPTIONS:</b>				-1 .....	\$492.00	-23 .....	\$477.00 -VP.....\$324.00	-10*.....	249.00	-33 .....	806.00 -Z.....0.00	-20 .....	574.00	-IRMA..	1,325.00																																																											
LIST PRICE																																																																																							
PIPE SIZE	3", 4"		\$1,045.00																																																																																				
<b>ADD FOR OPTIONS:</b>																																																																																							
-1 .....	\$492.00	-23 .....	\$477.00 -VP.....\$324.00																																																																																				
-10*.....	249.00	-33 .....	806.00 -Z.....0.00																																																																																				
-20 .....	574.00	-IRMA..	1,325.00																																																																																				
	<b>22200 COMBINATION DRAIN/OVERFLOW, MEDIUM SUMP w/CI DOME</b>																																																																																						
	<table border="1"> <thead> <tr> <th colspan="4">LIST PRICE</th> </tr> <tr> <th>PIPE SIZE</th> <th colspan="2">2" - 6"</th> <th>\$2,788.00</th> </tr> </thead> <tbody> <tr> <td colspan="4"><b>ADD FOR OPTIONS:</b></td> </tr> <tr> <td>-10*.....</td> <td>\$249.00</td> <td>-33 .....</td> <td>\$1,341.00 -T.....\$226.00</td> </tr> <tr> <td>-10-20*..</td> <td>511.00</td> <td>-66 .....</td> <td>223.00 -VP.....324.00</td> </tr> <tr> <td>-20 .....</td> <td>1,120.00</td> <td>-IRMA..</td> <td>1,794.00 -X.....0.00</td> </tr> <tr> <td>-23 .....</td> <td>1,166.00</td> <td>-RCSD.....</td> <td>\$0.00 -Z.....0.00</td> </tr> </tbody> </table> <p>*Specify Height, Price Per Inch</p>				LIST PRICE				PIPE SIZE	2" - 6"		\$2,788.00	<b>ADD FOR OPTIONS:</b>				-10*.....	\$249.00	-33 .....	\$1,341.00 -T.....\$226.00	-10-20*..	511.00	-66 .....	223.00 -VP.....324.00	-20 .....	1,120.00	-IRMA..	1,794.00 -X.....0.00	-23 .....	1,166.00	-RCSD.....	\$0.00 -Z.....0.00																																																							
LIST PRICE																																																																																							
PIPE SIZE	2" - 6"		\$2,788.00																																																																																				
<b>ADD FOR OPTIONS:</b>																																																																																							
-10*.....	\$249.00	-33 .....	\$1,341.00 -T.....\$226.00																																																																																				
-10-20*..	511.00	-66 .....	223.00 -VP.....324.00																																																																																				
-20 .....	1,120.00	-IRMA..	1,794.00 -X.....0.00																																																																																				
-23 .....	1,166.00	-RCSD.....	\$0.00 -Z.....0.00																																																																																				
	<b>22500 COMBINATION DRAIN/OVERFLOW, LARGE SUMP AND POLY DOME</b>																																																																																						
	<table border="1"> <thead> <tr> <th colspan="4">LIST PRICE</th> </tr> <tr> <th>PIPE SIZE</th> <th>2", 3", 4"</th> <th>5", 6"</th> <th>8"</th> </tr> </thead> <tbody> <tr> <td></td> <td>\$3,572.00</td> <td>\$4,442.00</td> <td>\$5,310.00</td> </tr> </tbody> </table> <p><b>ADD FOR OPTIONS:</b></p> <table border="1"> <tbody> <tr> <td>-1 .....</td> <td>\$696.00</td> <td>-23 .....</td> <td>\$2,381.00</td> <td>-RCSD.....</td> <td>\$0.00</td> </tr> <tr> <td>-4 .....</td> <td>534.00</td> <td>-26 .....</td> <td>705.00</td> <td>-VP.....</td> <td>355.00</td> </tr> <tr> <td>-10*.....</td> <td>1,894.00</td> <td>-33 .....</td> <td>1,441.00</td> <td>-T.....</td> <td>226.00</td> </tr> <tr> <td>-10-20*3,</td> <td>007.00</td> <td>-66 .....</td> <td>1,065.00</td> <td>-X.....</td> <td>0.00</td> </tr> <tr> <td>-20 .....</td> <td>2,750.00</td> <td>-AE.....</td> <td>2,041.00</td> <td>-Y.....</td> <td>0.00</td> </tr> <tr> <td>-21-22..</td> <td>1,649.00</td> <td>-AER.....</td> <td>571.00</td> <td>-Z.....</td> <td>0.00</td> </tr> <tr> <td>-22 .....</td> <td>601.00</td> <td>-IRMA..</td> <td>2,263.00</td> <td></td> <td></td> </tr> </tbody> </table> <p>*Specify Height, Price Each 4" or Fraction.</p>				LIST PRICE				PIPE SIZE	2", 3", 4"	5", 6"	8"		\$3,572.00	\$4,442.00	\$5,310.00	-1 .....	\$696.00	-23 .....	\$2,381.00	-RCSD.....	\$0.00	-4 .....	534.00	-26 .....	705.00	-VP.....	355.00	-10*.....	1,894.00	-33 .....	1,441.00	-T.....	226.00	-10-20*3,	007.00	-66 .....	1,065.00	-X.....	0.00	-20 .....	2,750.00	-AE.....	2,041.00	-Y.....	0.00	-21-22..	1,649.00	-AER.....	571.00	-Z.....	0.00	-22 .....	601.00	-IRMA..	2,263.00																															
LIST PRICE																																																																																							
PIPE SIZE	2", 3", 4"	5", 6"	8"																																																																																				
	\$3,572.00	\$4,442.00	\$5,310.00																																																																																				
-1 .....	\$696.00	-23 .....	\$2,381.00	-RCSD.....	\$0.00																																																																																		
-4 .....	534.00	-26 .....	705.00	-VP.....	355.00																																																																																		
-10*.....	1,894.00	-33 .....	1,441.00	-T.....	226.00																																																																																		
-10-20*3,	007.00	-66 .....	1,065.00	-X.....	0.00																																																																																		
-20 .....	2,750.00	-AE.....	2,041.00	-Y.....	0.00																																																																																		
-21-22..	1,649.00	-AER.....	571.00	-Z.....	0.00																																																																																		
-22 .....	601.00	-IRMA..	2,263.00																																																																																				
	<b>23500 14" PROMENADE TOP, LARGE SUMP</b>																																																																																						
	<table border="1"> <thead> <tr> <th colspan="5">LIST PRICE</th> </tr> <tr> <th>PIPE SIZE</th> <th>23500</th> <th>23500-AE</th> <th>23500-6</th> <th>23500-IRMA</th> </tr> </thead> <tbody> <tr> <td>2", 3", 4"</td> <td>\$1,728.00</td> <td>\$2,746.00</td> <td>\$3,619.00</td> <td>\$2,854.00</td> </tr> <tr> <td>5", 6"</td> <td>2,134.00</td> <td>3,150.00</td> <td>4,025.00</td> <td>3,262.00</td> </tr> <tr> <td>8"</td> <td>2,532.00</td> <td>3,548.00</td> <td>N/A</td> <td>3,659.00</td> </tr> <tr> <td>10"</td> <td>3,383.00</td> <td>4,401.00</td> <td>N/A</td> <td>4,512.00</td> </tr> </tbody> </table> <p><b>ADD FOR OPTIONS:</b></p> <table border="1"> <tbody> <tr> <td>-1 .....</td> <td>\$348.00</td> <td>-20 .....</td> <td>\$1,274.00</td> <td>-CR.....</td> <td>\$601.00</td> </tr> <tr> <td>-2 .....</td> <td>392.00</td> <td>-36 .....</td> <td>881.00</td> <td>-IRMA..</td> <td>1,127.00</td> </tr> <tr> <td>-3 .....</td> <td>736.00</td> <td>-37-50</td> <td>2,324.00</td> <td>-PG.....</td> <td>1,117.00</td> </tr> <tr> <td>-3C.....</td> <td>528.00</td> <td>-37-51</td> <td>2,048.00</td> <td>-VP.....</td> <td>210.00</td> </tr> <tr> <td>-4 .....</td> <td>268.00</td> <td>-50 .....</td> <td>1,436.00</td> <td>-T.....</td> <td>112.00</td> </tr> <tr> <td>-6 .....</td> <td>1,891.00</td> <td>-51 .....</td> <td>1,175.00</td> <td>-X.....</td> <td>0.00</td> </tr> <tr> <td>-10*.....</td> <td>949.00</td> <td>-66 .....</td> <td>530.00</td> <td>-Y.....</td> <td>0.00</td> </tr> <tr> <td>-10-20*..</td> <td>1,504.00</td> <td>-AE.....</td> <td>1,016.00</td> <td>-Z.....</td> <td>0.00</td> </tr> <tr> <td>-18 .....</td> <td>851.00</td> <td>-ARE....</td> <td>2,335.00</td> <td></td> <td></td> </tr> </tbody> </table> <p>* Specify Height, Price Each 4" or Fraction</p>				LIST PRICE					PIPE SIZE	23500	23500-AE	23500-6	23500-IRMA	2", 3", 4"	\$1,728.00	\$2,746.00	\$3,619.00	\$2,854.00	5", 6"	2,134.00	3,150.00	4,025.00	3,262.00	8"	2,532.00	3,548.00	N/A	3,659.00	10"	3,383.00	4,401.00	N/A	4,512.00	-1 .....	\$348.00	-20 .....	\$1,274.00	-CR.....	\$601.00	-2 .....	392.00	-36 .....	881.00	-IRMA..	1,127.00	-3 .....	736.00	-37-50	2,324.00	-PG.....	1,117.00	-3C.....	528.00	-37-51	2,048.00	-VP.....	210.00	-4 .....	268.00	-50 .....	1,436.00	-T.....	112.00	-6 .....	1,891.00	-51 .....	1,175.00	-X.....	0.00	-10*.....	949.00	-66 .....	530.00	-Y.....	0.00	-10-20*..	1,504.00	-AE.....	1,016.00	-Z.....	0.00	-18 .....	851.00	-ARE....	2,335.00	
LIST PRICE																																																																																							
PIPE SIZE	23500	23500-AE	23500-6	23500-IRMA																																																																																			
2", 3", 4"	\$1,728.00	\$2,746.00	\$3,619.00	\$2,854.00																																																																																			
5", 6"	2,134.00	3,150.00	4,025.00	3,262.00																																																																																			
8"	2,532.00	3,548.00	N/A	3,659.00																																																																																			
10"	3,383.00	4,401.00	N/A	4,512.00																																																																																			
-1 .....	\$348.00	-20 .....	\$1,274.00	-CR.....	\$601.00																																																																																		
-2 .....	392.00	-36 .....	881.00	-IRMA..	1,127.00																																																																																		
-3 .....	736.00	-37-50	2,324.00	-PG.....	1,117.00																																																																																		
-3C.....	528.00	-37-51	2,048.00	-VP.....	210.00																																																																																		
-4 .....	268.00	-50 .....	1,436.00	-T.....	112.00																																																																																		
-6 .....	1,891.00	-51 .....	1,175.00	-X.....	0.00																																																																																		
-10*.....	949.00	-66 .....	530.00	-Y.....	0.00																																																																																		
-10-20*..	1,504.00	-AE.....	1,016.00	-Z.....	0.00																																																																																		
-18 .....	851.00	-ARE....	2,335.00																																																																																				
<h3>Roof Drain Option Descriptions</h3> <ul style="list-style-type: none"> <li>-AE LEVELEZE® Adjustable Extension</li> <li>-AER Adjustable Extension using Threaded Rods and Hardware</li> <li>-ARE Acid-Resisting Epoxy</li> <li>-CR Clamping Drain Receiver</li> <li>-FG Flat Cast Iron Grate</li> <li>-FG2 ADA/HP Flat Grate</li> <li>-FG3 ADA/HP Flat Grate</li> <li>-IRMA Perforated Stainless Steel Extension</li> <li>-OR LEVELEZE® Adjustable Extension with O-Ring</li> <li>-PC Perforated Cover</li> <li>-PG PARKING GRATE</li> <li>-RCSD Recessed Drain Receiver</li> <li>-VP Vandal-Proof Dome or Grate</li> <li>-1 Deck Clamp Assembly</li> <li>-2 Drain Receiver</li> <li>-3 Deck Clamp Assembly and Drain Receiver</li> <li>-3C Drain Receiver and Drain Receiver Clips</li> <li>-4 Secondary Flashing Clamp (use with -AE Only)</li> <li>-6 Extra Wide Flange Drain Body (2" through 6", -X Only)</li> <li>-10 Fixed Extended Collar, Cast Iron</li> <li>-10-20 Fixed Extended Collar, Galvanized</li> <li>-16 Internal Water Guard 2-6" Outlets Only</li> <li>-17 2" High Solid Clamping Collar</li> <li>-18 Extra Deep Sump</li> <li>-19 Clamp Collar w/Perforated SS Gravel Guard</li> <li>-20 Galvanized Cast Iron Parts</li> <li>-21 Galvanized Cast Iron Dome Only</li> <li>-22 Cast Iron Dome</li> <li>-23 Rough Bronze Dome</li> <li>-26 Aluminum Dome</li> <li>-33 Stainless Mesh Screen-Covered Dome</li> <li>-36 Ductile Iron Grate (Cast Iron Top Only)</li> <li>-37-50 HD Ductile Iron Undergrate Laminated Top, Satin Finish Nikaloy</li> <li>-37-51 HD Ductile Iron Undergrate Laminated Top, Satin Finish Bronze</li> <li>-50 C.I. Undergrate Laminated Top, Satin Finish Nikaloy</li> <li>-51 C.I. Undergrate Laminated Top, Satin Finish Bronze</li> </ul> <p><b>Outlets</b></p> <ul style="list-style-type: none"> <li>-66 No-Hub Side Outlet, 2" - 6"</li> <li>-T Threaded Outlet</li> <li>-TSO Threaded Side Outlet</li> <li>-X Inside Caulk Outlet</li> <li>-Y Hub Outlet w/Gasket, 2"-4"</li> <li>-Z No-Hub Spigot Outlet</li> </ul>																																																																																							





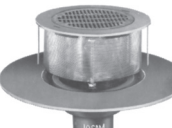



# ROOF DRAINS

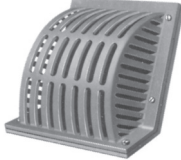

A WATTS Brand

<p><b>23510</b></p> 	<p><b>15" EXTRA HEAVY-DUTY PARKING GRATE, LARGE SUMP</b></p> <table border="1"> <thead> <tr> <th colspan="4">LIST PRICE</th> </tr> <tr> <th>PIPE SIZE</th> <th>2", 3", 4"</th> <th>5", 6"</th> <th>8"</th> </tr> </thead> <tbody> <tr> <td></td> <td>\$2,239.00</td> <td>\$2,654.00</td> <td>\$3,168.00</td> </tr> </tbody> </table> <p><b>ADD FOR OPTIONS:</b></p> <table> <tr> <td>-1 .....</td><td>\$348.00</td> <td>-20 .....</td><td>\$1,274.00</td> <td>-T .....</td><td>\$112.00</td> </tr> <tr> <td>-2 .....</td><td>391.00</td> <td>-36 .....</td><td>879.00</td> <td>-VP .....</td><td>208.00</td> </tr> <tr> <td>-3 .....</td><td>736.00</td> <td>-50 .....</td><td>3,689.00</td> <td>-X .....</td><td>0.00</td> </tr> <tr> <td>-3C .....</td><td>528.00</td> <td>-51 .....</td><td>3,312.00</td> <td>-Y .....</td><td>0.00</td> </tr> <tr> <td>-10* .....</td><td>1,016.00</td> <td>-66 .....</td><td>530.00</td> <td>-Z .....</td><td>0.00</td> </tr> <tr> <td>-10-20* .....</td><td>1,432.00</td> <td>-CR .....</td><td>601.00</td> <td></td><td></td> </tr> </table> <p>* Specify Height, Price Each 4" or Fraction</p>	LIST PRICE				PIPE SIZE	2", 3", 4"	5", 6"	8"		\$2,239.00	\$2,654.00	\$3,168.00	-1 .....	\$348.00	-20 .....	\$1,274.00	-T .....	\$112.00	-2 .....	391.00	-36 .....	879.00	-VP .....	208.00	-3 .....	736.00	-50 .....	3,689.00	-X .....	0.00	-3C .....	528.00	-51 .....	3,312.00	-Y .....	0.00	-10* .....	1,016.00	-66 .....	530.00	-Z .....	0.00	-10-20* .....	1,432.00	-CR .....	601.00			<p><b>24030</b></p> 	<p><b>13" SUPER-FLO® TOP, MEDIUM SUMP COMPOSITION DECK FLANGE</b></p> <table border="1"> <thead> <tr> <th colspan="3">LIST PRICE</th> </tr> <tr> <th>PIPE SIZE</th> <th>4", 5", 6", 8"</th> <th>\$2,553.00</th> </tr> </thead> </table> <p><b>ADD FOR OPTIONS:</b></p> <table> <tr> <td>-1 .....</td><td>\$323.00</td> <td>-31 .....</td><td>\$163.00</td> <td>-66 .....</td><td>\$223.00</td> </tr> <tr> <td>-20 .....</td><td>1,147.00</td> <td>-36 .....</td><td>377.00</td> <td>-HP .....</td><td>153.00</td> </tr> <tr> <td>-29 .....</td><td>347.00</td> <td>-50 .....</td><td>1,036.00</td> <td>-VP .....</td><td>212.00</td> </tr> <tr> <td>-29-20 .....</td><td>633.00</td> <td>-51 .....</td><td>943.00</td> <td>-X .....</td><td>0.00</td> </tr> </table>	LIST PRICE			PIPE SIZE	4", 5", 6", 8"	\$2,553.00	-1 .....	\$323.00	-31 .....	\$163.00	-66 .....	\$223.00	-20 .....	1,147.00	-36 .....	377.00	-HP .....	153.00	-29 .....	347.00	-50 .....	1,036.00	-VP .....	212.00	-29-20 .....	633.00	-51 .....	943.00	-X .....	0.00			
LIST PRICE																																																																																				
PIPE SIZE	2", 3", 4"	5", 6"	8"																																																																																	
	\$2,239.00	\$2,654.00	\$3,168.00																																																																																	
-1 .....	\$348.00	-20 .....	\$1,274.00	-T .....	\$112.00																																																																															
-2 .....	391.00	-36 .....	879.00	-VP .....	208.00																																																																															
-3 .....	736.00	-50 .....	3,689.00	-X .....	0.00																																																																															
-3C .....	528.00	-51 .....	3,312.00	-Y .....	0.00																																																																															
-10* .....	1,016.00	-66 .....	530.00	-Z .....	0.00																																																																															
-10-20* .....	1,432.00	-CR .....	601.00																																																																																	
LIST PRICE																																																																																				
PIPE SIZE	4", 5", 6", 8"	\$2,553.00																																																																																		
-1 .....	\$323.00	-31 .....	\$163.00	-66 .....	\$223.00																																																																															
-20 .....	1,147.00	-36 .....	377.00	-HP .....	153.00																																																																															
-29 .....	347.00	-50 .....	1,036.00	-VP .....	212.00																																																																															
-29-20 .....	633.00	-51 .....	943.00	-X .....	0.00																																																																															
<p><b>23710</b></p> 	<p><b>11" PROMENADE TOP, MEDIUM SUMP</b></p> <table border="1"> <thead> <tr> <th colspan="3">LIST PRICE</th> </tr> <tr> <th>PIPE SIZE</th> <th>2"- 6"</th> <th>\$1,546.00</th> </tr> </thead> </table> <p><b>ADD FOR OPTIONS:</b></p> <table> <tr> <td>-1 .....</td><td>\$213.00</td> <td>-20 .....</td><td>\$718.00</td> <td>-T .....</td><td>\$112.00</td> </tr> <tr> <td>-2 .....</td><td>360.00</td> <td>-50 .....</td><td>1,055.00</td> <td>-VP .....</td><td>208.00</td> </tr> <tr> <td>-3 .....</td><td>574.00</td> <td>-51 .....</td><td>920.00</td> <td>-X .....</td><td>0.00</td> </tr> <tr> <td>-3C .....</td><td>497.00</td> <td>-66 .....</td><td>223.00</td> <td>-Z .....</td><td>0.00</td> </tr> <tr> <td>-12* .....</td><td>126.00</td> <td>-IRMA† .....</td><td>666.00</td> <td></td><td></td> </tr> </table> <p>* Specify Height, Price Per Inch † Price up to 4". Each additional inch, add \$110.00.</p>	LIST PRICE			PIPE SIZE	2"- 6"	\$1,546.00	-1 .....	\$213.00	-20 .....	\$718.00	-T .....	\$112.00	-2 .....	360.00	-50 .....	1,055.00	-VP .....	208.00	-3 .....	574.00	-51 .....	920.00	-X .....	0.00	-3C .....	497.00	-66 .....	223.00	-Z .....	0.00	-12* .....	126.00	-IRMA† .....	666.00			<p><b>24040</b></p> 	<p><b>9" SUPER-FLO® TOP, MEDIUM SUMP COMPOSITION DECK FLANGE</b></p> <table border="1"> <thead> <tr> <th colspan="3">LIST PRICE</th> </tr> <tr> <th>PIPE SIZE</th> <th>2", 3", 4"</th> <th>\$1,443.00</th> </tr> </thead> </table> <p><b>ADD FOR OPTIONS:</b></p> <table> <tr> <td>-1 .....</td><td>\$213.00</td> <td>-36 .....</td><td>\$299.00</td> <td>-66 .....</td><td>\$223.00</td> </tr> <tr> <td>-20 .....</td><td>860.00</td> <td>-38 .....</td><td>Deduct</td> <td>-HP .....</td><td>153.00</td> </tr> <tr> <td>-29 .....</td><td>197.00</td> <td>128.00</td> <td></td> <td>-VP .....</td><td>212.00</td> </tr> <tr> <td>-29-20 .....</td><td>296.00</td> <td>-50 .....</td><td>719.00</td> <td>-X .....</td><td>0.00</td> </tr> <tr> <td>-31 .....</td><td>163.00</td> <td>-51 .....</td><td>591.00</td> <td></td><td></td> </tr> </table>	LIST PRICE			PIPE SIZE	2", 3", 4"	\$1,443.00	-1 .....	\$213.00	-36 .....	\$299.00	-66 .....	\$223.00	-20 .....	860.00	-38 .....	Deduct	-HP .....	153.00	-29 .....	197.00	128.00		-VP .....	212.00	-29-20 .....	296.00	-50 .....	719.00	-X .....	0.00	-31 .....	163.00	-51 .....	591.00											
LIST PRICE																																																																																				
PIPE SIZE	2"- 6"	\$1,546.00																																																																																		
-1 .....	\$213.00	-20 .....	\$718.00	-T .....	\$112.00																																																																															
-2 .....	360.00	-50 .....	1,055.00	-VP .....	208.00																																																																															
-3 .....	574.00	-51 .....	920.00	-X .....	0.00																																																																															
-3C .....	497.00	-66 .....	223.00	-Z .....	0.00																																																																															
-12* .....	126.00	-IRMA† .....	666.00																																																																																	
LIST PRICE																																																																																				
PIPE SIZE	2", 3", 4"	\$1,443.00																																																																																		
-1 .....	\$213.00	-36 .....	\$299.00	-66 .....	\$223.00																																																																															
-20 .....	860.00	-38 .....	Deduct	-HP .....	153.00																																																																															
-29 .....	197.00	128.00		-VP .....	212.00																																																																															
-29-20 .....	296.00	-50 .....	719.00	-X .....	0.00																																																																															
-31 .....	163.00	-51 .....	591.00																																																																																	
<p><b>23730</b></p> 	<p><b>9" PROMENADE TOP, SMALL SUMP</b></p> <table border="1"> <thead> <tr> <th colspan="3">LIST PRICE</th> </tr> <tr> <th>PIPE SIZE</th> <th>2", 3", 4"</th> <th>\$1,176.00</th> </tr> </thead> </table> <p><b>ADD FOR OPTIONS:</b></p> <table> <tr> <td>-1 .....</td><td>\$213.00</td> <td>-20 .....</td><td>\$382.00</td> <td>-TSO † .....</td><td>\$267.00</td> </tr> <tr> <td>-2 .....</td><td>360.00</td> <td>-50 .....</td><td>612.00</td> <td>-VP .....</td><td>208.00</td> </tr> <tr> <td>-3 .....</td><td>574.00</td> <td>-51 .....</td><td>548.00</td> <td>-X .....</td><td>0.00</td> </tr> <tr> <td>-3C .....</td><td>477.00</td> <td>-66 .....</td><td>223.00</td> <td>-Y .....</td><td>0.00</td> </tr> <tr> <td>-12* .....</td><td>126.00</td> <td>-IRMA† .....</td><td>666.00</td> <td>-Z .....</td><td>0.00</td> </tr> <tr> <td>-12-20* .....</td><td>249.00</td> <td>-T .....</td><td>112.00</td> <td></td><td></td> </tr> </table> <p>* Specify Height, Price Per Inch † Price up to 4". Each additional inch, add \$110.00. ‡ Cannot be used with Drain Receiver</p>	LIST PRICE			PIPE SIZE	2", 3", 4"	\$1,176.00	-1 .....	\$213.00	-20 .....	\$382.00	-TSO † .....	\$267.00	-2 .....	360.00	-50 .....	612.00	-VP .....	208.00	-3 .....	574.00	-51 .....	548.00	-X .....	0.00	-3C .....	477.00	-66 .....	223.00	-Y .....	0.00	-12* .....	126.00	-IRMA† .....	666.00	-Z .....	0.00	-12-20* .....	249.00	-T .....	112.00			<p><b>24050</b></p> 	<p><b>GARAGE DRAIN, 13" SPECIAL-DUTY TOP, WIDE FLANGE</b></p> <table border="1"> <thead> <tr> <th colspan="3">LIST PRICE</th> </tr> <tr> <th>PIPE SIZE</th> <th>4"- 6"</th> <th>8"</th> </tr> </thead> <tbody> <tr> <td></td> <td>\$3,628.00</td> <td>\$4,054.00</td> </tr> </tbody> </table> <p><b>ADD FOR OPTIONS:</b></p> <table> <tr> <td>-1 .....</td><td>\$323.00</td> <td>-29-20 .....</td><td>\$638.00</td> <td>-51 .....</td><td>\$1,546.00</td> </tr> <tr> <td>-12* .....</td><td>126.00</td> <td>-31 .....</td><td>163.00</td> <td>-66 .....</td><td>223.00</td> </tr> <tr> <td>-20 .....</td><td>1,560.00</td> <td>-36 .....</td><td>377.00</td> <td>-HP .....</td><td>153.00</td> </tr> <tr> <td>-29 .....</td><td>296.00</td> <td>-50 .....</td><td>1,882.00</td> <td>-VP .....</td><td>212.00</td> </tr> <tr> <td></td><td></td> <td></td><td></td> <td>-X .....</td><td>0.00</td> </tr> </table> <p>* Specify Height, Price Per Inch</p>	LIST PRICE			PIPE SIZE	4"- 6"	8"		\$3,628.00	\$4,054.00	-1 .....	\$323.00	-29-20 .....	\$638.00	-51 .....	\$1,546.00	-12* .....	126.00	-31 .....	163.00	-66 .....	223.00	-20 .....	1,560.00	-36 .....	377.00	-HP .....	153.00	-29 .....	296.00	-50 .....	1,882.00	-VP .....	212.00					-X .....	0.00
LIST PRICE																																																																																				
PIPE SIZE	2", 3", 4"	\$1,176.00																																																																																		
-1 .....	\$213.00	-20 .....	\$382.00	-TSO † .....	\$267.00																																																																															
-2 .....	360.00	-50 .....	612.00	-VP .....	208.00																																																																															
-3 .....	574.00	-51 .....	548.00	-X .....	0.00																																																																															
-3C .....	477.00	-66 .....	223.00	-Y .....	0.00																																																																															
-12* .....	126.00	-IRMA† .....	666.00	-Z .....	0.00																																																																															
-12-20* .....	249.00	-T .....	112.00																																																																																	
LIST PRICE																																																																																				
PIPE SIZE	4"- 6"	8"																																																																																		
	\$3,628.00	\$4,054.00																																																																																		
-1 .....	\$323.00	-29-20 .....	\$638.00	-51 .....	\$1,546.00																																																																															
-12* .....	126.00	-31 .....	163.00	-66 .....	223.00																																																																															
-20 .....	1,560.00	-36 .....	377.00	-HP .....	153.00																																																																															
-29 .....	296.00	-50 .....	1,882.00	-VP .....	212.00																																																																															
				-X .....	0.00																																																																															
<p><b>23740</b></p> 	<p><b>8" HEAVY-DUTY TOP, MEDIUM SUMP</b></p> <table border="1"> <thead> <tr> <th colspan="3">LIST PRICE</th> </tr> <tr> <th>PIPE SIZE</th> <th>2", 3", 4"</th> <th>\$2,989.00</th> </tr> </thead> </table> <p><b>ADD FOR OPTIONS:</b></p> <table> <tr> <td>-1 .....</td><td>\$213.00</td> <td>-20 .....</td><td>\$411.00</td> <td>-T .....</td><td>\$112.00</td> </tr> <tr> <td>-2 .....</td><td>360.00</td> <td>-51 .....</td><td>Deduct</td> <td>-VP .....</td><td>208.00</td> </tr> <tr> <td>-3 .....</td><td>574.00</td> <td>114.00</td> <td></td> <td>-X .....</td><td>0.00</td> </tr> <tr> <td>-3C .....</td><td>477.00</td> <td>-66 .....</td><td>223.00</td> <td>-Y .....</td><td>0.00</td> </tr> <tr> <td>-12* .....</td><td>148.00</td> <td>-IRMA† .....</td><td>666.00</td> <td>-Z .....</td><td>0.00</td> </tr> <tr> <td>-12-20* .....</td><td>232.00</td> <td>-TSO ‡ .....</td><td>267.00</td> <td></td><td></td> </tr> </table> <p>* Specify Height, Price Per Inch † Price up to 4". Each additional inch, add \$110.00. ‡ Cannot be used with Drain Receiver</p>	LIST PRICE			PIPE SIZE	2", 3", 4"	\$2,989.00	-1 .....	\$213.00	-20 .....	\$411.00	-T .....	\$112.00	-2 .....	360.00	-51 .....	Deduct	-VP .....	208.00	-3 .....	574.00	114.00		-X .....	0.00	-3C .....	477.00	-66 .....	223.00	-Y .....	0.00	-12* .....	148.00	-IRMA† .....	666.00	-Z .....	0.00	-12-20* .....	232.00	-TSO ‡ .....	267.00			<p><b>24060</b></p> 	<p><b>15" SPECIAL-DUTY TOP COMPOSITION DECK FLANGE</b></p> <table border="1"> <thead> <tr> <th colspan="3">LIST PRICE</th> </tr> <tr> <th>PIPE SIZE</th> <th>4"- 6"</th> <th>8"</th> </tr> </thead> <tbody> <tr> <td></td> <td>\$4,523.00</td> <td>\$5,073.00</td> </tr> </tbody> </table> <p><b>ADD FOR OPTIONS:</b></p> <table> <tr> <td>-1 .....</td><td>\$347.00</td> <td>-29-20 .....</td><td>\$735.00</td> <td>-51 .....</td><td>\$1,120.00</td> </tr> <tr> <td>-20 .....</td><td>1,573.00</td> <td>-31 .....</td><td>377.00</td> <td>-66 .....</td><td>223.00</td> </tr> <tr> <td>-29 .....</td><td>444.00</td> <td>-50 .....</td><td>1,295.00</td> <td>-VP .....</td><td>212.00</td> </tr> <tr> <td></td><td></td> <td></td><td></td> <td>-X .....</td><td>0.00</td> </tr> </table> <p>* Specify Height, Price Per Inch</p>	LIST PRICE			PIPE SIZE	4"- 6"	8"		\$4,523.00	\$5,073.00	-1 .....	\$347.00	-29-20 .....	\$735.00	-51 .....	\$1,120.00	-20 .....	1,573.00	-31 .....	377.00	-66 .....	223.00	-29 .....	444.00	-50 .....	1,295.00	-VP .....	212.00					-X .....	0.00						
LIST PRICE																																																																																				
PIPE SIZE	2", 3", 4"	\$2,989.00																																																																																		
-1 .....	\$213.00	-20 .....	\$411.00	-T .....	\$112.00																																																																															
-2 .....	360.00	-51 .....	Deduct	-VP .....	208.00																																																																															
-3 .....	574.00	114.00		-X .....	0.00																																																																															
-3C .....	477.00	-66 .....	223.00	-Y .....	0.00																																																																															
-12* .....	148.00	-IRMA† .....	666.00	-Z .....	0.00																																																																															
-12-20* .....	232.00	-TSO ‡ .....	267.00																																																																																	
LIST PRICE																																																																																				
PIPE SIZE	4"- 6"	8"																																																																																		
	\$4,523.00	\$5,073.00																																																																																		
-1 .....	\$347.00	-29-20 .....	\$735.00	-51 .....	\$1,120.00																																																																															
-20 .....	1,573.00	-31 .....	377.00	-66 .....	223.00																																																																															
-29 .....	444.00	-50 .....	1,295.00	-VP .....	212.00																																																																															
				-X .....	0.00																																																																															
<p><b>24020</b></p> 	<p><b>9" SUPER-FLO® TOP, MEDIUM SUMP COMPOSITION DECK FLANGE</b></p> <table border="1"> <thead> <tr> <th colspan="3">LIST PRICE</th> </tr> <tr> <th>PIPE SIZE</th> <th>2", 3", 4"</th> <th>\$1,159.00</th> </tr> </thead> </table> <p><b>ADD FOR OPTIONS:</b></p> <table> <tr> <td>-1 .....</td><td>\$213.00</td> <td>-31 .....</td><td>\$163.00</td> <td>-51 .....</td><td>\$462.00</td> </tr> <tr> <td>-20 .....</td><td>977.00</td> <td>-36 .....</td><td>301.00</td> <td>-66 .....</td><td>223.00</td> </tr> <tr> <td>-29 .....</td><td>93.00</td> <td>-38 .....</td><td>Deduct</td> <td>-HP .....</td><td>153.00</td> </tr> <tr> <td>-29-20 .....</td><td>208.00</td> <td>128.00</td> <td></td> <td>-VP .....</td><td>212.00</td> </tr> <tr> <td></td><td></td> <td>-50 .....</td><td>469.00</td> <td>-X .....</td><td>0.00</td> </tr> </table>	LIST PRICE			PIPE SIZE	2", 3", 4"	\$1,159.00	-1 .....	\$213.00	-31 .....	\$163.00	-51 .....	\$462.00	-20 .....	977.00	-36 .....	301.00	-66 .....	223.00	-29 .....	93.00	-38 .....	Deduct	-HP .....	153.00	-29-20 .....	208.00	128.00		-VP .....	212.00			-50 .....	469.00	-X .....	0.00	<p><b>24200</b></p> 	<p><b>16" PROMENADE TOP ALL LEVEL BONDING FLANGE</b></p> <table border="1"> <thead> <tr> <th colspan="3">LIST PRICE</th> </tr> <tr> <th>PIPE SIZE</th> <th>2"- 6"</th> <th>\$6,913.00</th> </tr> </thead> </table> <p><b>ADD FOR OPTIONS:</b></p> <table> <tr> <td>-1 .....</td><td>\$347.00</td> <td>-51 .....</td><td>\$2,629.00</td> <td>-X .....</td><td>0.00</td> </tr> <tr> <td>-20 .....</td><td>1,374.00</td> <td>-66 .....</td><td>223.00</td> <td></td><td></td> </tr> <tr> <td>-50 .....</td><td>2,912.00</td> <td>-VP .....</td><td>212.00</td> <td></td><td></td> </tr> </table>	LIST PRICE			PIPE SIZE	2"- 6"	\$6,913.00	-1 .....	\$347.00	-51 .....	\$2,629.00	-X .....	0.00	-20 .....	1,374.00	-66 .....	223.00			-50 .....	2,912.00	-VP .....	212.00																							
LIST PRICE																																																																																				
PIPE SIZE	2", 3", 4"	\$1,159.00																																																																																		
-1 .....	\$213.00	-31 .....	\$163.00	-51 .....	\$462.00																																																																															
-20 .....	977.00	-36 .....	301.00	-66 .....	223.00																																																																															
-29 .....	93.00	-38 .....	Deduct	-HP .....	153.00																																																																															
-29-20 .....	208.00	128.00		-VP .....	212.00																																																																															
		-50 .....	469.00	-X .....	0.00																																																																															
LIST PRICE																																																																																				
PIPE SIZE	2"- 6"	\$6,913.00																																																																																		
-1 .....	\$347.00	-51 .....	\$2,629.00	-X .....	0.00																																																																															
-20 .....	1,374.00	-66 .....	223.00																																																																																	
-50 .....	2,912.00	-VP .....	212.00																																																																																	
		<p><b>24500</b></p> 	<p><b>SILL TYPE 4" DOME, SHALLOW SUMP</b></p> <table border="1"> <thead> <tr> <th colspan="4">LIST PRICE</th> </tr> <tr> <th>PIPE SIZE</th> <th>24500</th> <th>24500-45</th> <th>24500-90</th> </tr> </thead> <tbody> <tr> <td>2", 3"</td> <td>\$601.00</td> <td>\$762.00</td> <td>\$762.00</td> </tr> <tr> <td>4"</td> <td>872.00</td> <td>1,034.00</td> <td>1,034.00</td> </tr> </tbody> </table> <p><b>ADD FOR OPTIONS:</b></p> <table> <tr> <td>-20 .....</td><td>\$232.00</td> <td>-35 .....</td><td>\$0.00</td> <td>-90 .....</td><td>\$163.00</td> </tr> <tr> <td>-24 .....</td><td>126.00</td> <td>-45 .....</td><td>163.00</td> <td>-T .....</td><td>0.00</td> </tr> <tr> <td>-27 .....</td><td>114.00</td> <td>-50 .....</td><td>295.00</td> <td>-VP .....</td><td>78.00</td> </tr> <tr> <td>-33 .....</td><td>336.00</td> <td>-51 .....</td><td>171.00</td> <td></td><td></td> </tr> </table>	LIST PRICE				PIPE SIZE	24500	24500-45	24500-90	2", 3"	\$601.00	\$762.00	\$762.00	4"	872.00	1,034.00	1,034.00	-20 .....	\$232.00	-35 .....	\$0.00	-90 .....	\$163.00	-24 .....	126.00	-45 .....	163.00	-T .....	0.00	-27 .....	114.00	-50 .....	295.00	-VP .....	78.00	-33 .....	336.00	-51 .....	171.00																																											
LIST PRICE																																																																																				
PIPE SIZE	24500	24500-45	24500-90																																																																																	
2", 3"	\$601.00	\$762.00	\$762.00																																																																																	
4"	872.00	1,034.00	1,034.00																																																																																	
-20 .....	\$232.00	-35 .....	\$0.00	-90 .....	\$163.00																																																																															
-24 .....	126.00	-45 .....	163.00	-T .....	0.00																																																																															
-27 .....	114.00	-50 .....	295.00	-VP .....	78.00																																																																															
-33 .....	336.00	-51 .....	171.00																																																																																	





 <p><b>24700</b></p>	<p><b>PARAPET TYPE, SLOPING GRATE</b></p> <table border="1"> <thead> <tr> <th colspan="3">LIST PRICE</th> </tr> <tr> <th>PIPE SIZE</th> <th>2", 3", 4"</th> <th>5", 6"</th> </tr> </thead> <tbody> <tr> <td></td> <td>\$1,504.00</td> <td>\$2,728.00</td> </tr> </tbody> </table> <p><b>ADD FOR OPTIONS:</b></p> <table border="1"> <tbody> <tr> <td>-20 (2" - 4")</td> <td>\$340.00</td> <td>-51</td> <td>\$466.00</td> </tr> <tr> <td>-20 (5" - 6")</td> <td>687.00</td> <td>-61 (2" - 4")</td> <td>485.00</td> </tr> <tr> <td>-22</td> <td>Deduct 610.00</td> <td>-61 (5" - 6")</td> <td>810.00</td> </tr> <tr> <td>-24</td> <td>638.00</td> <td>-61-20 (2" - 4")</td> <td>695.00</td> </tr> <tr> <td>-45</td> <td>0.00</td> <td>-61-20 (5" - 6")</td> <td>902.00</td> </tr> <tr> <td>-50</td> <td>839.00</td> <td></td> <td></td> </tr> </tbody> </table>	LIST PRICE			PIPE SIZE	2", 3", 4"	5", 6"		\$1,504.00	\$2,728.00	-20 (2" - 4")	\$340.00	-51	\$466.00	-20 (5" - 6")	687.00	-61 (2" - 4")	485.00	-22	Deduct 610.00	-61 (5" - 6")	810.00	-24	638.00	-61-20 (2" - 4")	695.00	-45	0.00	-61-20 (5" - 6")	902.00	-50	839.00			 <p><b>25030</b></p>	<p><b>DOWNSPOUT BOOT, GALVANIZED</b></p> <table border="1"> <thead> <tr> <th colspan="3">LIST PRICE</th> </tr> <tr> <th></th> <th></th> <th></th> </tr> </thead> <tbody> <tr> <td>4x3</td> <td>25033</td> <td>\$2,133.00</td> </tr> <tr> <td>5x4</td> <td>25034</td> <td>2,358.00</td> </tr> <tr> <td>5x3</td> <td>25035</td> <td>2,582.00</td> </tr> </tbody> </table>	LIST PRICE						4x3	25033	\$2,133.00	5x4	25034	2,358.00	5x3	25035	2,582.00																															
LIST PRICE																																																																																		
PIPE SIZE	2", 3", 4"	5", 6"																																																																																
	\$1,504.00	\$2,728.00																																																																																
-20 (2" - 4")	\$340.00	-51	\$466.00																																																																															
-20 (5" - 6")	687.00	-61 (2" - 4")	485.00																																																																															
-22	Deduct 610.00	-61 (5" - 6")	810.00																																																																															
-24	638.00	-61-20 (2" - 4")	695.00																																																																															
-45	0.00	-61-20 (5" - 6")	902.00																																																																															
-50	839.00																																																																																	
LIST PRICE																																																																																		
4x3	25033	\$2,133.00																																																																																
5x4	25034	2,358.00																																																																																
5x3	25035	2,582.00																																																																																
 <p><b>24720</b></p>	<p><b>PARAPET TYPE, ANGLE GRATE</b></p> <table border="1"> <thead> <tr> <th colspan="3">LIST PRICE</th> </tr> <tr> <th>PIPE SIZE</th> <th>24720</th> <th>24720-45</th> </tr> </thead> <tbody> <tr> <td>2", 3", 4"</td> <td>\$949.00</td> <td>\$949.00</td> </tr> <tr> <td>5", 6"</td> <td>1,803.00</td> <td>1,803.00</td> </tr> </tbody> </table> <p><b>ADD FOR OPTIONS:</b></p> <table border="1"> <tbody> <tr> <td>-20 (2" - 4")</td> <td>\$343.00</td> <td>-50</td> <td>\$1,452.00</td> </tr> <tr> <td>-20 (5" - 6")</td> <td>687.00</td> <td>-51</td> <td>1,080.00</td> </tr> <tr> <td>-23 (2" - 4")</td> <td>612.00</td> <td>-61 (2" - 4")</td> <td>485.00</td> </tr> <tr> <td>-23 (5" - 6")</td> <td>1,001.00</td> <td>-61 (5" - 6")</td> <td>810.00</td> </tr> <tr> <td>-24 (2" - 4")</td> <td>1,279.00</td> <td>-61-20 (2" - 4")</td> <td>695.00</td> </tr> <tr> <td>-24 (5" - 6")</td> <td>2,091.00</td> <td>-61-20 (5" - 6")</td> <td>902.00</td> </tr> <tr> <td>-45</td> <td>0.00</td> <td>-VP</td> <td>88.00</td> </tr> </tbody> </table>	LIST PRICE			PIPE SIZE	24720	24720-45	2", 3", 4"	\$949.00	\$949.00	5", 6"	1,803.00	1,803.00	-20 (2" - 4")	\$343.00	-50	\$1,452.00	-20 (5" - 6")	687.00	-51	1,080.00	-23 (2" - 4")	612.00	-61 (2" - 4")	485.00	-23 (5" - 6")	1,001.00	-61 (5" - 6")	810.00	-24 (2" - 4")	1,279.00	-61-20 (2" - 4")	695.00	-24 (5" - 6")	2,091.00	-61-20 (5" - 6")	902.00	-45	0.00	-VP	88.00	 <p><b>25500</b></p>	<p><b>FLOSEPTOR®, LARGE SUMP</b></p> <table border="1"> <thead> <tr> <th colspan="3">LIST PRICE</th> </tr> <tr> <th>PIPE SIZE</th> <th>2", 3", 4"</th> <th>5", 6"</th> </tr> </thead> <tbody> <tr> <td></td> <td>\$1,343.00</td> <td>\$1,800.00</td> </tr> </tbody> </table> <p><b>ADD FOR OPTIONS:</b></p> <table border="1"> <tbody> <tr> <td>-AE</td> <td>\$1,016.00</td> <td>-1</td> <td>\$348.00</td> <td>-66</td> <td>\$530.00</td> </tr> <tr> <td>-AER</td> <td>601.00</td> <td>-2</td> <td>391.00</td> <td>T</td> <td>112.00</td> </tr> <tr> <td>-CR</td> <td>601.00</td> <td>-3</td> <td>736.00</td> <td>-X</td> <td>0.00</td> </tr> <tr> <td>-FG</td> <td>792.00</td> <td>-10*</td> <td>949.00</td> <td>-Y</td> <td>0.00</td> </tr> <tr> <td>-OR</td> <td>1,016.00</td> <td>-20</td> <td>1,274.00</td> <td>-Z</td> <td>0.00</td> </tr> </tbody> </table> <p>*Specify Height, Price Each 4" or Fraction</p>	LIST PRICE			PIPE SIZE	2", 3", 4"	5", 6"		\$1,343.00	\$1,800.00	-AE	\$1,016.00	-1	\$348.00	-66	\$530.00	-AER	601.00	-2	391.00	T	112.00	-CR	601.00	-3	736.00	-X	0.00	-FG	792.00	-10*	949.00	-Y	0.00	-OR	1,016.00	-20	1,274.00	-Z	0.00
LIST PRICE																																																																																		
PIPE SIZE	24720	24720-45																																																																																
2", 3", 4"	\$949.00	\$949.00																																																																																
5", 6"	1,803.00	1,803.00																																																																																
-20 (2" - 4")	\$343.00	-50	\$1,452.00																																																																															
-20 (5" - 6")	687.00	-51	1,080.00																																																																															
-23 (2" - 4")	612.00	-61 (2" - 4")	485.00																																																																															
-23 (5" - 6")	1,001.00	-61 (5" - 6")	810.00																																																																															
-24 (2" - 4")	1,279.00	-61-20 (2" - 4")	695.00																																																																															
-24 (5" - 6")	2,091.00	-61-20 (5" - 6")	902.00																																																																															
-45	0.00	-VP	88.00																																																																															
LIST PRICE																																																																																		
PIPE SIZE	2", 3", 4"	5", 6"																																																																																
	\$1,343.00	\$1,800.00																																																																																
-AE	\$1,016.00	-1	\$348.00	-66	\$530.00																																																																													
-AER	601.00	-2	391.00	T	112.00																																																																													
-CR	601.00	-3	736.00	-X	0.00																																																																													
-FG	792.00	-10*	949.00	-Y	0.00																																																																													
-OR	1,016.00	-20	1,274.00	-Z	0.00																																																																													
 <p><b>24900</b></p>	<p><b>PARAPET TYPE, ANGLE DOME GRATE</b></p> <table border="1"> <thead> <tr> <th colspan="3">LIST PRICE</th> </tr> <tr> <th>PIPE SIZE</th> <th>2" - 6"</th> <th></th> </tr> </thead> <tbody> <tr> <td></td> <td></td> <td>\$5,385.00</td> </tr> </tbody> </table> <p><b>ADD FOR OPTIONS:</b></p> <table border="1"> <tbody> <tr> <td>-20</td> <td>\$764.00</td> <td>-61 (5" - 6")</td> <td>\$810.00</td> </tr> <tr> <td>-24</td> <td>839.00</td> <td>-61-20 (2" - 4")</td> <td>695.00</td> </tr> <tr> <td>-50</td> <td>1,094.00</td> <td>-61-20 (5" - 6")</td> <td>902.00</td> </tr> <tr> <td>-51</td> <td>774.00</td> <td>-VP</td> <td>88.00</td> </tr> <tr> <td>-61 (2" - 4")</td> <td>485.00</td> <td></td> <td></td> </tr> </tbody> </table>	LIST PRICE			PIPE SIZE	2" - 6"				\$5,385.00	-20	\$764.00	-61 (5" - 6")	\$810.00	-24	839.00	-61-20 (2" - 4")	695.00	-50	1,094.00	-61-20 (5" - 6")	902.00	-51	774.00	-VP	88.00	-61 (2" - 4")	485.00			<p><b>Option Descriptions</b></p> <ul style="list-style-type: none"> <li>-AE LEVELEZE® Adjustable Extension</li> <li>-AER Adjustable Extension with Rods</li> <li>-BS Bird Screen</li> <li>-CR Clamping Drain Receiver</li> <li>-FG Flat Grate (Replaces Dome Strainer)</li> <li>-HP Heel-Proof Grate</li> <li>-IRMA Perforated Stainless Steel Extension</li> <li>-OR Adjustable Extension with O-Ring</li> <li>-SLT Slotted Cover (1/4")</li> <li>-VP Vandal-Proof Dome</li> <li>-1 Deck Clamp Assembly</li> <li>-2 Drain Receiver</li> <li>-3 Deck Clamp Assembly and Drain Receiver</li> <li>-3C Drain Receiver and Drain Receiver Clips</li> <li>-10 Fixed Extension Collar, Cast Iron</li> <li>-10-20 Fixed Extension Collar, Galvanized</li> <li>-12 Extended Flashing Collar, Cast Iron</li> <li>-12-20 Extended Flashing Collar, Galvanized</li> <li>-20 Galvanized Cast Iron Parts</li> <li>-22 Cast Iron Grate</li> <li>-23 Rough Bronze Grate</li> <li>-24 Rough Nikaloy Dome or Grate</li> <li>-27 High Dome</li> <li>-29 Sediment Bucket, Cast Iron</li> <li>-29-20 Sediment Bucket, Galvanized</li> <li>-31 Chain Anchored Grate</li> <li>-33 Stainless Mesh Screen-Covered Dome</li> <li>-35 Flat Grate</li> <li>-36 Ductile Iron Grate (Cast Iron Top Only)</li> <li>-38 Less Grate</li> <li>-50 C.I. Undergrate Laminated Top, Satin Finish Nikaloy</li> <li>-51 C.I. Undergrate Laminated Top, Satin Finish Bronze</li> <li>-61 Downspout Elbow, Cast Iron</li> <li>-61-20 Downspout Elbow, Galvanized</li> <li>-316 Type 316L Stainless Steel</li> </ul> <p>Outlets</p> <ul style="list-style-type: none"> <li>-45 Body with 45 Degree Threaded Outlet</li> <li>-66 No-Hub Side Outlet, 2" - 6"</li> <li>-90 Body with 90 Degree Threaded Outlet</li> <li>-PVC Metal Nozzle to fit PVC Pipe</li> <li>-T Threaded Outlet</li> <li>-TSO Threaded Side Outlet</li> <li>-X Inside Caulk Outlet</li> <li>-Y Hub Outlet with Gasket, 2" - 4"</li> <li>-Z No-Hub Spigot Outlet</li> </ul>																																																			
LIST PRICE																																																																																		
PIPE SIZE	2" - 6"																																																																																	
		\$5,385.00																																																																																
-20	\$764.00	-61 (5" - 6")	\$810.00																																																																															
-24	839.00	-61-20 (2" - 4")	695.00																																																																															
-50	1,094.00	-61-20 (5" - 6")	902.00																																																																															
-51	774.00	-VP	88.00																																																																															
-61 (2" - 4")	485.00																																																																																	
 <p><b>25000</b></p>	<p><b>PARAPET SCUPPER SLEEVE</b></p> <table border="1"> <thead> <tr> <th colspan="5">LIST PRICE</th> </tr> <tr> <th>Wall Thickness</th> <th>9"</th> <th>13"</th> <th>17"</th> <th>21"</th> </tr> </thead> <tbody> <tr> <td></td> <td>\$1,343.00</td> <td>\$1,526.00</td> <td>\$1,884.00</td> <td>\$2,013.00</td> </tr> </tbody> </table> <p><b>ADD FOR OPTIONS:</b></p> <table border="1"> <tbody> <tr> <td>-20</td> <td>\$340.00</td> </tr> </tbody> </table>	LIST PRICE					Wall Thickness	9"	13"	17"	21"		\$1,343.00	\$1,526.00	\$1,884.00	\$2,013.00	-20	\$340.00																																																																
LIST PRICE																																																																																		
Wall Thickness	9"	13"	17"	21"																																																																														
	\$1,343.00	\$1,526.00	\$1,884.00	\$2,013.00																																																																														
-20	\$340.00																																																																																	
 <p><b>25010</b></p>	<p><b>DOWNSPOUT NOZZLE</b></p> <table border="1"> <thead> <tr> <th colspan="6">LIST PRICE</th> </tr> <tr> <th>PIPE SIZE</th> <th>2", 3", 4"</th> <th>5", 6"</th> <th>8"</th> <th>10"</th> <th>*12"</th> </tr> </thead> <tbody> <tr> <td></td> <td>\$899.00</td> <td>\$2,134.00</td> <td>\$3,248.00</td> <td>\$4,215.00</td> <td>\$5,292.00</td> </tr> </tbody> </table> <p><b>ADD FOR OPTIONS:</b></p> <table border="1"> <tbody> <tr> <td>-24 (2" - 6")</td> <td>\$652.00</td> <td>-51 (10")</td> <td>\$557.00</td> </tr> <tr> <td>-24 (8")</td> <td>574.00</td> <td>-BS</td> <td>786.00</td> </tr> <tr> <td>-24 (10")</td> <td>769.00</td> <td>-PVC</td> <td>0.00</td> </tr> <tr> <td>-51 (2" - 6")</td> <td>411.00</td> <td>-T</td> <td>0.00</td> </tr> <tr> <td>-51 (8")</td> <td>432.00</td> <td>-Z**</td> <td>0.00</td> </tr> </tbody> </table> <p>* 12" Size No-Hub Only ** Bronze Only</p>	LIST PRICE						PIPE SIZE	2", 3", 4"	5", 6"	8"	10"	*12"		\$899.00	\$2,134.00	\$3,248.00	\$4,215.00	\$5,292.00	-24 (2" - 6")	\$652.00	-51 (10")	\$557.00	-24 (8")	574.00	-BS	786.00	-24 (10")	769.00	-PVC	0.00	-51 (2" - 6")	411.00	-T	0.00	-51 (8")	432.00	-Z**	0.00																																											
LIST PRICE																																																																																		
PIPE SIZE	2", 3", 4"	5", 6"	8"	10"	*12"																																																																													
	\$899.00	\$2,134.00	\$3,248.00	\$4,215.00	\$5,292.00																																																																													
-24 (2" - 6")	\$652.00	-51 (10")	\$557.00																																																																															
-24 (8")	574.00	-BS	786.00																																																																															
-24 (10")	769.00	-PVC	0.00																																																																															
-51 (2" - 6")	411.00	-T	0.00																																																																															
-51 (8")	432.00	-Z**	0.00																																																																															
 <p><b>25020</b></p>	<p><b>SPECIAL PURPOSE DOWNSPOUT COVER</b></p> <table border="1"> <thead> <tr> <th colspan="4">LIST PRICE</th> </tr> <tr> <th>PIPE SIZE</th> <th>2", 3", 4"</th> <th>5", 6"</th> <th>8"</th> </tr> </thead> <tbody> <tr> <td></td> <td>\$4,223.00</td> <td>\$4,498.00</td> <td>\$4,680.00</td> </tr> <tr> <th>PIPE SIZE</th> <th>10"</th> <th>12"</th> <th>15"</th> </tr> <tr> <td></td> <td>\$4,952.00</td> <td>\$5,252.00</td> <td>\$5,547.00</td> </tr> </tbody> </table> <p><b>ADD FOR OPTIONS:</b></p> <table border="1"> <tbody> <tr> <td>-316</td> <td>\$954.00</td> <td>-VP</td> <td>\$211.00</td> </tr> <tr> <td>-SLT</td> <td>0.00</td> <td>-Z (4" - 15")</td> <td>213.00</td> </tr> </tbody> </table>	LIST PRICE				PIPE SIZE	2", 3", 4"	5", 6"	8"		\$4,223.00	\$4,498.00	\$4,680.00	PIPE SIZE	10"	12"	15"		\$4,952.00	\$5,252.00	\$5,547.00	-316	\$954.00	-VP	\$211.00	-SLT	0.00	-Z (4" - 15")	213.00																																																					
LIST PRICE																																																																																		
PIPE SIZE	2", 3", 4"	5", 6"	8"																																																																															
	\$4,223.00	\$4,498.00	\$4,680.00																																																																															
PIPE SIZE	10"	12"	15"																																																																															
	\$4,952.00	\$5,252.00	\$5,547.00																																																																															
-316	\$954.00	-VP	\$211.00																																																																															
-SLT	0.00	-Z (4" - 15")	213.00																																																																															

# ROOF DRAINS





A WATTS Brand

	<b>FLO-SEPTOR®, MEDIUM SUMP</b>		
	<b>LIST PRICE</b>		
	<b>PIPE SIZE</b>	<b>2" - 6"</b>	\$1,036.00
<b>ADD FOR OPTIONS:</b>			
-1 .....	\$213.00	-10*.....	\$126.00
-2 .....	369.00	-20.....	280.00
-3 .....	583.00	-66.....	223.00
-T.....	\$112.00		
-X.....	0.00		
-Z.....	0.00		
* Price per inch			

	<b>FLO-SEPTOR®, SMALL SUMP</b>		
	<b>LIST PRICE</b>		
	<b>PIPE SIZE</b>	<b>2", 3", 4"</b>	\$843.00
<b>ADD FOR OPTIONS:</b>			
-1 .....	\$213.00	-66 .....	\$223.00
-2 .....	369.00	-T.....	112.00
-3 .....	583.00	-TSO*	313.00
-20 .....	280.00	-X.....	0.00
* Cannot be used with Drain Receiver			

	<b>EXPANSION JOINT</b>			
	<b>LIST PRICE</b>			
	<b>PIPE SIZE</b>	<b>2"</b>	<b>3"</b>	<b>4"</b>
	\$949.00	\$1,016.00	\$1,147.00	\$1,662.00
<b>PIPE SIZE</b>	<b>6"</b>	<b>8"</b>	<b>10"</b>	
	\$1,909.00	\$3,371.00	\$7,012.00	
<b>ADD FOR OPTIONS:</b>				
-BR (2" - 8").....	\$414.00			
-20 .....	\$256.00			

	<b>STACK FLASHING FITTING</b>			
	<b>LIST PRICE</b>			
	<b>PIPE SIZE</b>	<b>1 1/2"</b>	<b>2"</b>	<b>3"</b>
	\$270.00	\$270.00	\$313.00	
<b>PIPE SIZE</b>	<b>4"</b>	<b>5"</b>	<b>6"</b>	
	\$403.00	\$583.00	\$583.00	
<b>ADD FOR OPTIONS:</b>				
-20 .....	\$267.00			

	<b>VENT STACK FLASHING SLEEVE</b>			
	<b>LIST PRICE</b>			
	<b>PIPE SIZE</b>	<b>1 1/2"</b>	<b>2"</b>	<b>3"</b>
	\$88.00	\$88.00	\$156.00	
<b>PIPE SIZE</b>	<b>4"</b>	<b>5"</b>	<b>6"</b>	
	\$177.00	\$232.00	\$446.00	
<b>ADD FOR OPTIONS:</b>				
-20 .....	\$114.00			

	<b>VANDAL-PROOF VENT CAP</b>			
	<b>LIST PRICE</b>			
	<b>PIPE SIZE</b>	<b>1 1/2"</b>	<b>2"</b>	<b>2 1/2"</b>
	\$601.00	\$601.00	\$671.00	\$671.00
<b>PIPE SIZE</b>	<b>4"</b>	<b>5"</b>	<b>6"</b>	
	\$753.00	\$881.00	\$966.00	
<b>ADD FOR OPTIONS:</b>				
-20 .....	\$249.00	-63 .....	\$601.00	
-33 .....	380.00	-65 .....	652.00	









	<b>FLO-SET®, 15" DOME, LARGE SUMP</b>		
	<b>LIST PRICE</b>		
	<b>PIPE SIZE</b>	<b>28600</b>	<b>28600-AE</b>
	<b>2", 3", 4" 5", 6"</b>	\$2,694.00 \$3,131.00	\$3,711.00 \$4,148.00
<b>ADD FOR OPTIONS:</b>			
-1 .....	\$348.00	10-20*	\$1,504.00
-2 .....	391.00	-20 .....	1,274.00
-3 .....	736.00	-23 .....	1,191.00
-3C.....	528.00	-66 .....	530.00
-4 .....	268.00	-AE.....	1,016.00
-10* .....	949.00	-CR.....	601.00
-T.....	\$112.00		
-VP.....	177.00		
-X.....	0.00		
-Y.....	0.00		
-Z.....	0.00		
* Specify Height, Price Each 4" or Fraction			

	<b>ISOLATION DECK DRAIN</b>		
	<b>LIST PRICE</b>		
	<b>PIPE SIZE</b>	<b>2", 3", 4"</b>	<b>5", 6"</b>
	\$1,016.00	\$1,443.00	\$1,884.00
<b>ADD FOR OPTIONS:</b>			
-1 .....	\$348.00	-20 .....	\$1,176.00
-2 .....	392.00	-66 .....	530.00
-3 .....	736.00	-CR.....	601.00
-3C.....	528.00	-T.....	112.00
-17 .....	329.00	-WH.....	71.00
-X.....	0.00		
-Y.....	0.00		
-Z.....	0.00		

	<b>16" DOME, EXTRA LARGE SUMP</b>		
	<b>LIST PRICE</b>		
	<b>PIPE SIZE</b>	<b>8"</b>	<b>10"</b>
	\$2,711.00	\$2,982.00	\$3,376.00
<b>ADD FOR OPTIONS:</b>			
-1 .....	\$688.00	-10-20*	\$2,232.00
-2 .....	774.00	-17 .....	977.00
-3 .....	1,461.00	-174 .....	1,544.00
-10* .....	1,415.00	-20 .....	2,046.00
-AER...	\$1,292.00		
-VP.....	177.00		
-Z.....	0.00		
* Specify Height, Price Each 4" or Fraction			

## Roof Drain Option Descriptions

- AE LEVELEZE® Adjustable Extension
- AER Adjustable Extension using Threaded Rod Hardware
- BR Bronze Sleeve, 2" - 8"
- CR Clamping Drain Receiver
- VP Vandal-Proof Dome
- WH Weeping Holes
- 1 Deck Clamp Assembly
- 2 Drain Receiver
- 3 Deck Clamp Assembly and Drain Receiver
- 3C Drain Receiver and Drain Receiver Clips
- 4 Secondary Flashing Clamp (use with -AE Only)
- 10 Fixed Extension Collar, Cast Iron
- 10-20 Fixed Extension Collar, Galvanized
- 17 2" High Solid Clamping Collar
- 174 4" High Solid Clamping Collar
- 20 Galvanized Cast Iron Parts
- 23 Rough Bronze Dome
- 33 Stainless Steel Mesh-Covered
- 63 All Rough Bronze
- 65 All Rough Nikaloy
- Outlets
- 66 No-Hub Side Outlet, 2" - 6"
- T Threaded Outlet
- TSO Threaded Side Outlet
- X Inside Caulk Outlet
- Y Hub Outlet with Gasket, 2" - 4"
- Z No-Hub Spigot Outlet

	<b>ROUND NIKALOY SUPER-FLO® STRAINER</b>						<b>ROUND NIKALOY DOME STRAINER</b>																																																						
	<b>LIST PRICE</b>						<b>LIST PRICE</b>																																																						
<table border="1"> <thead> <tr> <th>Strainer</th> <th>Strainer Only</th> <th>With 30000†</th> <th>With 30304</th> <th>With 30000-ST</th> </tr> </thead> <tbody> <tr> <td>5A</td> <td>\$414.00</td> <td>\$684.00</td> <td>\$540.00</td> <td>1,331.00</td> </tr> <tr> <td>6A</td> <td>573.00</td> <td>843.00</td> <td>699.00</td> <td>1,491.00</td> </tr> <tr> <td>7A</td> <td>700.00</td> <td>970.00</td> <td>826.00</td> <td>1,618.00</td> </tr> <tr> <td>8A</td> <td>949.00</td> <td>1,219.00</td> <td>1,075.00</td> <td>1,867.00</td> </tr> <tr> <td>9A*</td> <td>1,394.00</td> <td>1,664.00</td> <td>1,520.00</td> <td>2,312.00</td> </tr> <tr> <td>10A*</td> <td>1,394.00</td> <td>1,664.00</td> <td>1,520.00</td> <td>2,312.00</td> </tr> </tbody> </table>	Strainer	Strainer Only	With 30000†	With 30304	With 30000-ST	5A	\$414.00	\$684.00	\$540.00	1,331.00	6A	573.00	843.00	699.00	1,491.00	7A	700.00	970.00	826.00	1,618.00	8A	949.00	1,219.00	1,075.00	1,867.00	9A*	1,394.00	1,664.00	1,520.00	2,312.00	10A*	1,394.00	1,664.00	1,520.00	2,312.00	<b>ADD FOR OPTIONS:</b> -2 (5A) ..... Deduct \$34.00    -DBC (8") ..... \$163.00 -2 (6A) ..... Deduct 86.00    -HD (5", 6") ..... 295.00 -2 (7A) ..... Deduct 50.00    -J ..... 543.00 -2 (8A) ..... Deduct 65.00    -SS (5A - 8A) ..... 658.00 -2 (9A, 10A)* ..... Deduct 88.00    -SS-LR (6A) ..... 1,903.00 -80 ..... 156.00    -SS-LR-MFP (6A) .. 3,938.00 -5A-CP ..... 64.00    -TSI ..... POA -6A-CP ..... 67.00    -VP ..... 78.00 -DBC (5", 6") ..... 89.00    * Not SUPER-FLO® Design					<table border="1"> <thead> <tr> <th>Strainer</th> <th>Strainer Only</th> <th>With 30000†</th> <th>With 30304</th> <th>With 30000-ST</th> </tr> </thead> <tbody> <tr> <td>5D</td> <td>\$700.00</td> <td>\$970.00</td> <td>\$826.00</td> <td>\$1,618.00</td> </tr> <tr> <td>6D</td> <td>898.00</td> <td>1,168.00</td> <td>1,024.00</td> <td>1,815.00</td> </tr> </tbody> </table>	Strainer	Strainer Only	With 30000†	With 30304	With 30000-ST	5D	\$700.00	\$970.00	\$826.00	\$1,618.00	6D	898.00	1,168.00	1,024.00	1,815.00	<b>ADD FOR OPTIONS:</b> -2 (5D) .... Deduct \$53.00    -J ..... \$543.00 -2 (6D) .... Deduct 112.00    -TSI ..... POA -80 ..... 156.00    -VP ..... 78.00 †For 6" pipe size add \$655.00 to 30000 price				
Strainer	Strainer Only	With 30000†	With 30304	With 30000-ST																																																									
5A	\$414.00	\$684.00	\$540.00	1,331.00																																																									
6A	573.00	843.00	699.00	1,491.00																																																									
7A	700.00	970.00	826.00	1,618.00																																																									
8A	949.00	1,219.00	1,075.00	1,867.00																																																									
9A*	1,394.00	1,664.00	1,520.00	2,312.00																																																									
10A*	1,394.00	1,664.00	1,520.00	2,312.00																																																									
Strainer	Strainer Only	With 30000†	With 30304	With 30000-ST																																																									
5D	\$700.00	\$970.00	\$826.00	\$1,618.00																																																									
6D	898.00	1,168.00	1,024.00	1,815.00																																																									
	<b>ROUND NIKALOY STRAINER w/CLAMP DEVICE</b>						<b>ROUND NIKALOY TRACTOR STRAINER</b>																																																						
	<b>LIST PRICE</b>						<b>LIST PRICE</b>																																																						
<table border="1"> <thead> <tr> <th>Strainer</th> <th>Strainer Only</th> <th>With 30000†</th> <th>With 30304</th> <th>With 30000-ST</th> </tr> </thead> <tbody> <tr> <td>6AD</td> <td>\$1,996.00</td> <td>\$2,266.00</td> <td>\$2,122.00</td> <td>\$2,914.00</td> </tr> </tbody> </table>	Strainer	Strainer Only	With 30000†	With 30304	With 30000-ST	6AD	\$1,996.00	\$2,266.00	\$2,122.00	\$2,914.00	<b>ADD FOR OPTIONS:</b> -2 ..... Deduct \$227.00    -J ..... \$543.00 -80 ..... 156.00    -TSI ..... POA -VP ..... 78.00 †For 6" pipe size add \$655.00 to 30000 price					<table border="1"> <thead> <tr> <th>Strainer</th> <th>Strainer Only</th> <th>With 30000†</th> <th>With 30304</th> <th>With 30000-ST</th> </tr> </thead> <tbody> <tr> <td>6E</td> <td>1,051.00</td> <td>1,321.00</td> <td>1,177.00</td> <td>\$1,969.00</td> </tr> <tr> <td>7E</td> <td>1,327.00</td> <td>1,597.00</td> <td>1,453.00</td> <td>2,245.00</td> </tr> <tr> <td>9E</td> <td>1,946.00</td> <td>2,216.00</td> <td>2,072.00</td> <td>2,863.00</td> </tr> </tbody> </table>	Strainer	Strainer Only	With 30000†	With 30304	With 30000-ST	6E	1,051.00	1,321.00	1,177.00	\$1,969.00	7E	1,327.00	1,597.00	1,453.00	2,245.00	9E	1,946.00	2,216.00	2,072.00	2,863.00	<b>ADD FOR OPTIONS:</b> -2 (6E) ..... Deduct \$86.00    -J ..... \$543.00 -2 (7E) ..... Deduct 134.00    -SS (6E) ..... 658.00 -2 (9E) ..... Deduct 156.00    -SS (7E) ..... 658.00 -80 ..... 156.00    -TSI ..... POA -93 (7E) ... Deduct 820.00    -VP ..... 78.00 †For 6" pipe size add \$655.00 to 30000 price																								
Strainer	Strainer Only	With 30000†	With 30304	With 30000-ST																																																									
6AD	\$1,996.00	\$2,266.00	\$2,122.00	\$2,914.00																																																									
Strainer	Strainer Only	With 30000†	With 30304	With 30000-ST																																																									
6E	1,051.00	1,321.00	1,177.00	\$1,969.00																																																									
7E	1,327.00	1,597.00	1,453.00	2,245.00																																																									
9E	1,946.00	2,216.00	2,072.00	2,863.00																																																									
	<b>ROUND NIKALOY STRAINER w/TILE FLANGE</b>						<b>ROUND NIKALOY TRACTOR STRAINER w/EXTENDER RIM</b>																																																						
	<b>LIST PRICE</b>						<b>LIST PRICE</b>																																																						
<table border="1"> <thead> <tr> <th>Strainer</th> <th>Strainer Only</th> <th>With 30000†</th> <th>With 30304</th> <th>With 30000-ST</th> </tr> </thead> <tbody> <tr> <td>6AF</td> <td>\$1,327.00</td> <td>\$1,597.00</td> <td>\$1,453.00</td> <td>\$2,245.00</td> </tr> </tbody> </table>	Strainer	Strainer Only	With 30000†	With 30304	With 30000-ST	6AF	\$1,327.00	\$1,597.00	\$1,453.00	\$2,245.00	<b>ADD FOR OPTIONS:</b> -2 ..... Deduct \$134.00    -TSI ..... POA -80 ..... 156.00    -VP ..... 78.00 -J ..... 543.00 †For 6" pipe size add \$655.00 to 30000 price					<table border="1"> <thead> <tr> <th>Strainer</th> <th>Strainer Only</th> <th>With 30000†</th> <th>With 30304</th> <th>With 30000-ST</th> </tr> </thead> <tbody> <tr> <td>6E1</td> <td>1,120.00</td> <td>\$1,390.00</td> <td>\$1,246.00</td> <td>\$2,038.00</td> </tr> <tr> <td>7E1</td> <td>1,327.00</td> <td>1,597.00</td> <td>1,453.00</td> <td>2,245.00</td> </tr> <tr> <td>9E1</td> <td>1,967.00</td> <td>2,237.00</td> <td>2,093.00</td> <td>2,884.00</td> </tr> </tbody> </table>	Strainer	Strainer Only	With 30000†	With 30304	With 30000-ST	6E1	1,120.00	\$1,390.00	\$1,246.00	\$2,038.00	7E1	1,327.00	1,597.00	1,453.00	2,245.00	9E1	1,967.00	2,237.00	2,093.00	2,884.00	<b>ADD FOR OPTIONS:</b> -2 (6E1) . Deduct \$153.00    -J ..... \$543.00 -2 (7E1) ... Deduct 138.00    -TSI ..... POA -2 (9E1) ... Deduct 184.00    -VP ..... 78.00 -80 ..... 156.00 †For 6" pipe size add \$655.00 to 30000 price																								
Strainer	Strainer Only	With 30000†	With 30304	With 30000-ST																																																									
6AF	\$1,327.00	\$1,597.00	\$1,453.00	\$2,245.00																																																									
Strainer	Strainer Only	With 30000†	With 30304	With 30000-ST																																																									
6E1	1,120.00	\$1,390.00	\$1,246.00	\$2,038.00																																																									
7E1	1,327.00	1,597.00	1,453.00	2,245.00																																																									
9E1	1,967.00	2,237.00	2,093.00	2,884.00																																																									
	<b>ROUND NIKALOY NON-CLOG STRAINER w/INTEGRAL BUCKET</b>						<b>ROUND NIKALOY STRAINER w/ROUND FUNNEL</b>																																																						
	<b>LIST PRICE</b>						<b>LIST PRICE</b>																																																						
<table border="1"> <thead> <tr> <th>Strainer</th> <th>Strainer Only</th> <th>With 30000†</th> <th>With 30304</th> <th>With 30000-ST</th> </tr> </thead> <tbody> <tr> <td>5C</td> <td>\$1,100.00</td> <td>\$1,370.00</td> <td>\$1,226.00</td> <td>\$2,018.00</td> </tr> </tbody> </table>	Strainer	Strainer Only	With 30000†	With 30304	With 30000-ST	5C	\$1,100.00	\$1,370.00	\$1,226.00	\$2,018.00	<b>ADD FOR OPTIONS:</b> -2 ..... Deduct \$64.00    -VP ..... 78.00 -TSI ..... POA †For 6" pipe size add \$655.00 to 30000 price					<table border="1"> <thead> <tr> <th>Strainer</th> <th>Strainer Only</th> <th>With 30000†</th> <th>With 30304</th> <th>With 30000-ST</th> </tr> </thead> <tbody> <tr> <td>7E2</td> <td>\$1,313.00</td> <td>\$1,582.00</td> <td>\$1,439.00</td> <td>\$2,230.00</td> </tr> </tbody> </table>	Strainer	Strainer Only	With 30000†	With 30304	With 30000-ST	7E2	\$1,313.00	\$1,582.00	\$1,439.00	\$2,230.00	<b>ADD FOR OPTIONS:</b> -2 ..... Deduct \$134.00    -TSI ..... POA -80 ..... 156.00    -VP ..... 78.00 -J ..... 543.00 †For 6" pipe size add \$655.00 to 30000 price																																		
Strainer	Strainer Only	With 30000†	With 30304	With 30000-ST																																																									
5C	\$1,100.00	\$1,370.00	\$1,226.00	\$2,018.00																																																									
Strainer	Strainer Only	With 30000†	With 30304	With 30000-ST																																																									
7E2	\$1,313.00	\$1,582.00	\$1,439.00	\$2,230.00																																																									

### Strainer Option Descriptions









-CP	Chrome Plated	-TSI	Trap Seal Insert
-DBC	Debris Cover	-VP	Secured Grate, Vandal-Proof Screws
-HD	Heavy-Duty Heel Proof (Nikaloy Only)	-2	Satin Finish Bronze
-J	Backwater Valve	-63	Spanner Wrench
-SS	Stainless Steel	-80	Perforated Stainless Steel Basket
-SS-LR	SS Ligature Resistant	-93	Cast Iron Strainer
-SS-LR-MFP	SS Ligature Resistant, Mirror Polish Finish		











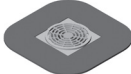
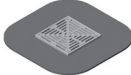

# FLOOR DRAINS • Strainers

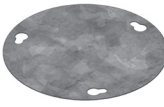

A WATTS Brand

 <p><b>E3</b></p>	<p align="center"><b>ROUND NIKALOY STRAINER w/OVAL FUNNEL</b></p> <table border="1"> <thead> <tr> <th colspan="5">LIST PRICE</th> </tr> <tr> <th>Strainer</th> <th>Strainer Only</th> <th>With 30000†</th> <th>With 30304</th> <th>With 30000-ST</th> </tr> </thead> <tbody> <tr> <td>7E3</td> <td>\$1,960.00</td> <td>\$2,230.00</td> <td>\$2,086.00</td> <td>\$2,878.00</td> </tr> </tbody> </table> <p>ADD FOR OPTIONS:</p> <p>-2 ..... Deduct \$134.00    -TSI ..... POA              -80 ..... 156.00    -VP ..... 78.00              -J ..... 543.00</p> <p>†For 6" pipe size add \$655.00 to 30000 price</p>	LIST PRICE					Strainer	Strainer Only	With 30000†	With 30304	With 30000-ST	7E3	\$1,960.00	\$2,230.00	\$2,086.00	\$2,878.00	 <p><b>G</b></p>	<p align="center"><b>ROUND NIKALOY STRAINER w/SOLID HINGED COVER</b></p> <table border="1"> <thead> <tr> <th colspan="5">LIST PRICE</th> </tr> <tr> <th>Strainer</th> <th>Strainer Only</th> <th>With 30000†</th> <th>With 30304</th> <th>With 30000-ST</th> </tr> </thead> <tbody> <tr> <td>5G</td> <td>\$971.00</td> <td>\$1,241.00</td> <td>1,097.00</td> <td>\$1,889.00</td> </tr> <tr> <td>6G</td> <td>1,104.00</td> <td>1,373.00</td> <td>1,230.00</td> <td>2,021.00</td> </tr> <tr> <td>7G</td> <td>1,719.00</td> <td>1,989.00</td> <td>1,845.00</td> <td>2,637.00</td> </tr> <tr> <td>8G</td> <td>1,746.00</td> <td>2,016.00</td> <td>1,872.00</td> <td>2,664.00</td> </tr> </tbody> </table> <p>ADD FOR OPTIONS:</p> <p>-2 (5G).... Deduct \$78.00    -J ..... \$543.00              -2 (6G).... Deduct 153.00    -TSI ..... POA              -2 (7G).... Deduct 210.00    -VP ..... 78.00              -2 (8G).... Deduct 156.00</p> <p>†For 6" pipe size add \$655.00 to 30000 price</p>	LIST PRICE					Strainer	Strainer Only	With 30000†	With 30304	With 30000-ST	5G	\$971.00	\$1,241.00	1,097.00	\$1,889.00	6G	1,104.00	1,373.00	1,230.00	2,021.00	7G	1,719.00	1,989.00	1,845.00	2,637.00	8G	1,746.00	2,016.00	1,872.00	2,664.00
LIST PRICE																																																
Strainer	Strainer Only	With 30000†	With 30304	With 30000-ST																																												
7E3	\$1,960.00	\$2,230.00	\$2,086.00	\$2,878.00																																												
LIST PRICE																																																
Strainer	Strainer Only	With 30000†	With 30304	With 30000-ST																																												
5G	\$971.00	\$1,241.00	1,097.00	\$1,889.00																																												
6G	1,104.00	1,373.00	1,230.00	2,021.00																																												
7G	1,719.00	1,989.00	1,845.00	2,637.00																																												
8G	1,746.00	2,016.00	1,872.00	2,664.00																																												
 <p><b>F</b></p>	<p align="center"><b>ROUND NIKALOY STRAINER w/SOLID THREADED COVER</b></p> <table border="1"> <thead> <tr> <th colspan="5">LIST PRICE</th> </tr> <tr> <th>Strainer</th> <th>Strainer Only</th> <th>With 30000†</th> <th>With 30304</th> <th>With 30000-ST</th> </tr> </thead> <tbody> <tr> <td>6F</td> <td>\$1,347.00</td> <td>\$1,617.00</td> <td>\$1,473.00</td> <td>\$2,265.00</td> </tr> </tbody> </table> <p>ADD FOR OPTIONS:</p> <p>-2 ..... Deduct \$106.00    -80 ..... \$156.00              -63 ..... 197.00    -J ..... 543.00              -TSI ..... POA</p> <p>†For 6" pipe size add \$655.00 to 30000 price</p>	LIST PRICE					Strainer	Strainer Only	With 30000†	With 30304	With 30000-ST	6F	\$1,347.00	\$1,617.00	\$1,473.00	\$2,265.00	 <p><b>H</b></p>	<p align="center"><b>ROUND NIKALOY STRAINER w/HINGED GRATE</b></p> <table border="1"> <thead> <tr> <th colspan="5">LIST PRICE</th> </tr> <tr> <th>Strainer</th> <th>Strainer Only</th> <th>With 30000†</th> <th>With 30304</th> <th>With 30000-ST</th> </tr> </thead> <tbody> <tr> <td>5H</td> <td>\$810.00</td> <td>1,079.00</td> <td>\$936.00</td> <td>\$1,727.00</td> </tr> <tr> <td>6H</td> <td>898.00</td> <td>1,168.00</td> <td>1,024.00</td> <td>1,815.00</td> </tr> <tr> <td>7H</td> <td>1,104.00</td> <td>1,373.00</td> <td>1,230.00</td> <td>2,021.00</td> </tr> <tr> <td>8H</td> <td>1,243.00</td> <td>1,513.00</td> <td>1,369.00</td> <td>2,161.00</td> </tr> </tbody> </table> <p>ADD FOR OPTIONS:</p> <p>-2 (5H) .... Deduct \$59.00    -80 (6H - 8H).... \$156.00              -2 (6H) ..... Deduct 86.00    -J ..... 543.00              -2 (7H) ..... Deduct 50.00    -TSI ..... POA              -2 (8H) .... Deduct 112.00    -VP ..... 78.00</p> <p>†For 6" pipe size add \$655.00 to 30000 price</p>	LIST PRICE					Strainer	Strainer Only	With 30000†	With 30304	With 30000-ST	5H	\$810.00	1,079.00	\$936.00	\$1,727.00	6H	898.00	1,168.00	1,024.00	1,815.00	7H	1,104.00	1,373.00	1,230.00	2,021.00	8H	1,243.00	1,513.00	1,369.00	2,161.00
LIST PRICE																																																
Strainer	Strainer Only	With 30000†	With 30304	With 30000-ST																																												
6F	\$1,347.00	\$1,617.00	\$1,473.00	\$2,265.00																																												
LIST PRICE																																																
Strainer	Strainer Only	With 30000†	With 30304	With 30000-ST																																												
5H	\$810.00	1,079.00	\$936.00	\$1,727.00																																												
6H	898.00	1,168.00	1,024.00	1,815.00																																												
7H	1,104.00	1,373.00	1,230.00	2,021.00																																												
8H	1,243.00	1,513.00	1,369.00	2,161.00																																												
 <p><b>F4, F6</b></p>	<p align="center"><b>ROUND NIKALOY FUNNEL ASSEMBLIES</b></p> <table border="1"> <thead> <tr> <th colspan="2">LIST PRICE</th> </tr> <tr> <th>Funnel</th> <th></th> </tr> </thead> <tbody> <tr> <td>F4</td> <td>\$608.00</td> </tr> <tr> <td>F6</td> <td>899.00</td> </tr> </tbody> </table> <p>ADD FOR OPTIONS:</p> <p>-2 ..... Deduct \$88.00    -93 (F4) . Deduct \$355.00              -92 (F4) ... Deduct 273.00    -93 (F6) ... Deduct 490.00              -92 (F6) ... Deduct 412.00    -ARE ..... 295.00</p>	LIST PRICE		Funnel		F4	\$608.00	F6	899.00	 <p><b>M</b></p>	<p align="center"><b>ROUND CHROME PLATED OVERFLOW STANDPIPE w/DOME</b></p> <table border="1"> <thead> <tr> <th colspan="5">LIST PRICE</th> </tr> <tr> <th>Strainer</th> <th>Strainer Only</th> <th>With 30000†</th> <th>With 30304</th> <th>With 30000-ST</th> </tr> </thead> <tbody> <tr> <td>2M</td> <td>\$2,531.00</td> <td>\$2,800.00</td> <td>\$2,657.00</td> <td>\$3,448.00</td> </tr> <tr> <td>3M</td> <td>3,233.00</td> <td>3,503.00</td> <td>3,359.00</td> <td>4,151.00</td> </tr> </tbody> </table> <p>ADD FOR OPTIONS:</p> <p>-2 (2M).. Deduct \$432.00    -24 (3M).. Deduct 543.00              -2 (3M).... Deduct 268.00    -PF ..... 495.00              -24 (2M).. Deduct 405.00</p> <p>†For 6" pipe size add \$655.00 to 30000 price</p> <p><b>For Each Inch Over 6" Standard</b></p> <table border="1"> <thead> <tr> <th></th> <th>CP</th> <th>-2</th> </tr> </thead> <tbody> <tr> <td>Add for 2M</td> <td>\$193.00</td> <td>\$141.00</td> </tr> <tr> <td>Add for 3M</td> <td>273.00</td> <td>242.00</td> </tr> </tbody> </table>	LIST PRICE					Strainer	Strainer Only	With 30000†	With 30304	With 30000-ST	2M	\$2,531.00	\$2,800.00	\$2,657.00	\$3,448.00	3M	3,233.00	3,503.00	3,359.00	4,151.00		CP	-2	Add for 2M	\$193.00	\$141.00	Add for 3M	273.00	242.00								
LIST PRICE																																																
Funnel																																																
F4	\$608.00																																															
F6	899.00																																															
LIST PRICE																																																
Strainer	Strainer Only	With 30000†	With 30304	With 30000-ST																																												
2M	\$2,531.00	\$2,800.00	\$2,657.00	\$3,448.00																																												
3M	3,233.00	3,503.00	3,359.00	4,151.00																																												
	CP	-2																																														
Add for 2M	\$193.00	\$141.00																																														
Add for 3M	273.00	242.00																																														
 <p><b>F8, F9</b></p>	<p align="center"><b>OVAL NIKALOY FUNNEL ASSEMBLIES</b></p> <table border="1"> <thead> <tr> <th colspan="2">LIST PRICE</th> </tr> <tr> <th>Funnel</th> <th></th> </tr> </thead> <tbody> <tr> <td>F8</td> <td>\$608.00</td> </tr> <tr> <td>F9</td> <td>1,260.00</td> </tr> </tbody> </table> <p>ADD FOR OPTIONS:</p> <p>-2 ..... Deduct \$88.00    -93 (F8) . Deduct \$355.00              -92 (F8) ... Deduct 273.00    -93 (F9) ... Deduct 649.00              -92 (F9) ... Deduct 568.00    -ARE ..... 295.00</p>	LIST PRICE		Funnel		F8	\$608.00	F9	1,260.00	 <p><b>P</b></p>	<p align="center"><b>ANGLE NIKALOY STRAINER</b></p> <table border="1"> <thead> <tr> <th colspan="5">LIST PRICE</th> </tr> <tr> <th>Strainer</th> <th>Strainer Only</th> <th>With 30000†</th> <th>With 30304</th> <th>With 30000-ST</th> </tr> </thead> <tbody> <tr> <td>4P</td> <td>\$2,531.00</td> <td>\$2,800.00</td> <td>\$2,657.00</td> <td>\$3,448.00</td> </tr> <tr> <td>6P</td> <td>3,233.00</td> <td>3,503.00</td> <td>3,359.00</td> <td>4,151.00</td> </tr> </tbody> </table> <p>ADD FOR OPTIONS:</p> <p>-2 (4P) ... Deduct \$213.00    -80 ..... \$156.00              -2 (6P).... Deduct 268.00    -TSI ..... POA              -VP ..... 78.00</p> <p>†For 6" pipe size add \$655.00 to 30000 price</p>	LIST PRICE					Strainer	Strainer Only	With 30000†	With 30304	With 30000-ST	4P	\$2,531.00	\$2,800.00	\$2,657.00	\$3,448.00	6P	3,233.00	3,503.00	3,359.00	4,151.00																	
LIST PRICE																																																
Funnel																																																
F8	\$608.00																																															
F9	1,260.00																																															
LIST PRICE																																																
Strainer	Strainer Only	With 30000†	With 30304	With 30000-ST																																												
4P	\$2,531.00	\$2,800.00	\$2,657.00	\$3,448.00																																												
6P	3,233.00	3,503.00	3,359.00	4,151.00																																												
 <p><b>F52, F53</b></p>	<p align="center"><b>ROUND CAST IRON FUNNEL ASSEMBLIES</b></p> <table border="1"> <thead> <tr> <th colspan="2">LIST PRICE</th> </tr> <tr> <th>Funnel</th> <th></th> </tr> </thead> <tbody> <tr> <td>F52</td> <td>\$466.00</td> </tr> <tr> <td>F53</td> <td>623.00</td> </tr> </tbody> </table> <p>ADD FOR OPTIONS:</p> <p>-1 ..... \$771.00    -92 ..... \$184.00</p>	LIST PRICE		Funnel		F52	\$466.00	F53	623.00																																							
LIST PRICE																																																
Funnel																																																
F52	\$466.00																																															
F53	623.00																																															

<b>R</b> 	<b>RECTANGULAR NIKALOY STRAINER</b>					<b>WF6A WF6S</b>  	<b>NIKALOY STRAINERS FOR COMPOSITION DECKS</b>				
	<b>LIST PRICE</b>						<b>LIST PRICE</b>				
	Strainer	Strainer Only	With 30000†	With 30304	With 30000-ST	Strainer	Strainer Only	With 30000†	With 30304	With 30000-ST	
	5R	\$1,243.00	\$1,513.00	\$1,369.00	\$2,161.00	6A	\$1,540.00	\$1,810.00	\$1,666.00	\$2,458.00	
	6R	1,784.00	2,054.00	1,910.00	2,702.00	6S	1,719.00	1,989.00	1,845.00	2,637.00	
	7R	1,911.00	2,181.00	2,037.00	2,829.00	<b>ADD FOR OPTIONS:</b>					
	8R	2,884.00	3,154.00	3,010.00	3,802.00	-2 (6A).....	Deduct \$86.00	-J.....	\$543.00		
<b>ADD FOR OPTIONS:</b>						-2 (6S).....	Deduct 50.00	-TSI.....	POA		
	-2 (5R).....	Deduct \$112.00		-TSI.....	POA	-80.....	156.00	-VP.....	78.00		
	-2 (6R, 7R).....	Deduct 193.00		-VP.....	78.00	Can be used with all Floor Drain Bodies on this Page.					
	-2 (8R).....	Deduct 375.00		†For 6" pipe size add \$655.00	to 30000 price	†For 6" pipe size add \$655.00 to 30000 price					
	-80.....	156.00									
	-J.....	543.00									
<b>S</b> 	<b>SQUARE NIKALOY SUPER-FLO® STRAINER</b>					<b>NBRG</b>  	<b>1/4" NIKALOY RIM AND GRATE EXTENSION</b>				
	<b>LIST PRICE</b>						<b>LIST PRICE</b>				
	Strainer	Strainer Only	With 30000†	With 30304	With 30000-ST	Type No.	NBRG	Type No. Rim Only	NBR* (1/4" Rim Only)		
	5S	\$649.00	\$919.00	\$775.00	\$1,567.00	5A-NBRG	\$194.00	5ANBR†	\$62.00		
	6S	753.00	1,023.00	879.00	1,671.00	6A-NBRG	221.00	6ANBR	84.00		
	8S	1,214.00	1,484.00	1,340.00	2,132.00	* Standard strainer grates will not fit NBR rims.					
	9S	1,619.00	1,889.00	1,745.00	2,537.00	† 5ANBR Can be used with Nikaloy Top 55000-1. (Can not be used with 4" X and 6" Z)					
<b>ADD FOR OPTIONS:</b>						<b>BODIES ONLY</b>					
	-2 (5S).....	Deduct \$78.00		-DBC (5", 6").....	\$89.00	<b>30000</b>					
	-2 (6S).....	Deduct 50.00		-DBC (8").....	163.00	<b>BODY ASSEMBLY</b>					
	-2 (8S).....	Deduct 138.00		-HD (5", 6").....	295.00	<b>LIST PRICE</b>					
	-2 (9S)*.....	Deduct 156.00		-J.....	543.00	PIPE SIZE	30000	30000-TSO	30002-ST 30003-ST	30000-PD	
	-5S-CP.....	78.00		-SS (5S - 8S).....	658.00	2" - 4" (Z)	\$270.00	\$583.00	\$918.00	1,016.00	
	-6S-CP.....	93.00		-TSI.....	POA		925.00	—	—	—	
	-80.....	156.00		-VP.....	78.00	<b>ADD FOR OPTIONS:</b>					
* Not SUPER-FLO® Design †For 6" pipe size add \$655.00 to 30000 price						-49.....	\$0.00	-PD.....	\$746.00		
	-2 (5S).....	Deduct \$78.00		-J.....	\$543.00	-50.....	STD	-ST.....	646.00		
	-2 (6T).....	Deduct 59.00		-SC (6T).....	360.00	-91.....	1,729.00	-T.....	112.00		
	-2 (9T).....	Deduct 156.00		-TSI.....	POA	-92.....	280.00	-TSI†.....	POA		
	-80 (6T, 9T).....	156.00		-VP.....	78.00	-ARE.....	249.00	-TSO.....	313.00		
†For 6" pipe size add \$655.00 to 30000 price						-CC4.....	795.00	-X.....	0.00		
	-2 (5T).....	Deduct \$78.00		-J.....	\$543.00	-MD.....	156.00	-Y.....	0.00		
	-2 (6T).....	Deduct 59.00		-SC (6T).....	360.00	-PFB.....	201.00	-Z (2" - 4").....	0.00		
	-2 (9T).....	Deduct 156.00		-TSI.....	POA	†Available up to 4" only					
	-80 (6T, 9T).....	156.00		-VP.....	78.00						
<b>T</b> 	<b>SQUARE NIKALOY STRAINER w/HINGED GRATE</b>						<b>30000-1</b>				
	<b>LIST PRICE</b>						<b>LIST PRICE</b>				
	Strainer	Strainer Only	With 30000†	With 30304	With 30000-ST	PIPE SIZE	30000	30000-TSO	30002-ST 30003-ST	30000-PD	
	5T	\$949.00	1,219.00	1,075.00	\$1,867.00	2" - 4" (Z)	\$270.00	\$583.00	\$918.00	1,016.00	
	6T	1,147.00	1,416.00	1,273.00	2,064.00		925.00	—	—	—	
	9T	2,084.00	2,354.00	2,210.00	3,002.00	<b>ADD FOR OPTIONS:</b>					
<b>ADD FOR OPTIONS:</b>						-49.....	\$0.00	-PD.....	\$746.00		
	-2 (5T).....	Deduct \$78.00		-J.....	\$543.00	-50.....	STD	-ST.....	646.00		
	-2 (6T).....	Deduct 59.00		-SC (6T).....	360.00	-91.....	1,729.00	-T.....	112.00		
	-2 (9T).....	Deduct 156.00		-TSI.....	POA	-92.....	280.00	-TSI†.....	POA		
	-80 (6T, 9T).....	156.00		-VP.....	78.00	-ARE.....	249.00	-TSO.....	313.00		
†For 6" pipe size add \$655.00 to 30000 price						-CC4.....	795.00	-X.....	0.00		
	-2 (5T).....	Deduct \$78.00		-J.....	\$543.00	-MD.....	156.00	-Y.....	0.00		
	-2 (6T).....	Deduct 59.00		-SC (6T).....	360.00	-PFB.....	201.00	-Z (2" - 4").....	0.00		
	-2 (9T).....	Deduct 156.00		-TSI.....	POA	†Available up to 4" only					
	-80 (6T, 9T).....	156.00		-VP.....	78.00						
<b>W</b> 	<b>CAST IRON STRAINER EXTENSION</b>					<b>30000-PD</b> 	<b>SECURITY BODY ASSEMBLY FOR PRISONS</b>				
	<b>LIST PRICE</b>						<b>LIST PRICE</b>				
	Strainer	Strainer Only	With 30000†	With 30304	With 30000-ST	PIPE SIZE	30000-PD				
	2W	\$197.00	\$467.00	\$323.00	1,115.00	2" - 3"	\$1,016.00				
	4W	355.00	625.00	481.00	1,273.00	<b>ADD FOR OPTIONS:</b>					
	6W	530.00	800.00	656.00	1,448.00	-50.....	\$0.00	-C.....	\$0.00		
<b>ADD FOR OPTIONS:</b>						-92.....	280.00	-T.....	0.00		
	-TSI.....	POA				Can be used with all Floor Drain Bodies on this page & previous. †For 6" pipe size add \$655.00 to 30000 price					
<b>DBC</b> 	<b>DEBRIS COVER</b>					<b>30000-TSO</b> 	<b>BODY ASSEMBLY w/THREADED SIDE OUTLET</b>				
	<b>LIST PRICE</b>						<b>LIST PRICE</b>				
	Type No.					PIPE SIZE	30000-TSO				
	5A-DBC, 6A-DBC				\$89.00	2" - 4"	\$583.00				
	5S-DBC, 6S-DBC				89.00	<b>ADD FOR OPTIONS:</b>					
	8A-DBC, 8S-DBC				163.00	-49.....	\$0.00	-ARE.....	\$249.00		
						-50.....	0.00				
						-92.....	280.00				

Square not depicted.

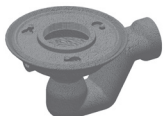
	<b>BODY ASSEMBLY w/SHALLOW THREADED OUTLET TRAP</b>	
	<b>LIST PRICE</b>	
	<b>PIPE SIZE</b>	<b>30000-ST</b>
	<b>2" - 3"</b>	\$918.00
	<b>ADD FOR OPTIONS:</b>	

-49 .....	\$0.00	-ARE .....	\$249.00
-50 .....	STD	-TSI .....	POA
-92 .....	280.00	-Z .....	0.00

	<b>NO-HUB CAST IRON BODY</b>	
	<b>LIST PRICE</b>	
	<b>PIPE SIZE</b>	<b>30304</b>
	<b>4"</b>	\$126.00

	<b>BODY ASSEMBLY w/TRAP &amp; FLUSH w/FLOOR CLEANOUT</b>		
	<b>LIST PRICE</b>		
	<b>PIPE SIZE</b>	<b>30500</b>	
	<b>2" - 4"</b>	\$1,619.00	
	<b>ADD FOR OPTIONS:</b>		
	-49 .....	\$213.00	-60 .....

-50 .....	213.00	-92 .....	753.00
-51 .....	495.00	-C .....	0.00
-52 .....	495.00	-Z .....	0.00

	<b>BODY w/2" SHALLOW TRAP &amp; ROUND CHROME PLATED STRAINER</b>	
	<b>LIST PRICE</b>	
	<b>PIPE SIZE</b>	<b>30802-4CP</b>
	<b>2"</b>	\$780.00
	<b>ADD FOR OPTIONS:</b>	

-LT .....	Deduct \$313.00	-T .....	\$0.00
-SQ .....	93.00	-Z .....	0.00

Option Descriptions	
<b>Strainers</b> -ARE Acid-Resisting Epoxy -CP Chrome Plated -DBC Debris Cover -HD Heavy-Duty Heel Proof (Nikaloy Only) -J Backwater Valve -LT Less Shallow Trap -PF Perforated Standpipe -SC Solid Cover -SS Stainless Steel -SQ Square Top -TSI Trap Seal Insert -VP Secured Grate, Vandal-Proof Screws -2 Satin Finish Bronze -24 Less Dome -80 Perforated Stainless Steel Basket -92 Galvanized Cast Iron -93 Cast Iron	<b>Bodies Only</b> -ARE Acid-Resisting Epoxy -C Bolted Flashing Clamp Device -CC4 Clamp Collar with 4" Thread -MD PVC Clamp Collar with 3" Socket Connection -PD Prison Drain -PFB Pre-Fabricated Base -ST Shallow Trap -49 3/4" Primer Tap -50 1/2" Primer Tap -51 1-1/2" Threaded Auxiliary Inlet -52 2" Threaded Auxiliary Inlet -60 Backwater Valve -91 Rough Bronze Body -92 Galvanized Cast Iron Parts  <b>Outlets</b> -T Threaded Outlet -TSO Threaded Side Outlet -X Inside Caulk Outlet -Y Hub Outlet with Gasket -Z No-Hub Outlet

### EXPLANATION OF FLOOR DRAIN WEIGHT LOADS

Apart from their primary purpose of receiving and conveying liquids, floor drains, as integral components of the floor, must be structurally suitable to withstand the anticipated loads that will be imposed on the floor. Weight support requirements of the drain vary with the location, construction, and service condition. The top loading classifications as published in Floor Drain Standard ANSI/ASME A112.6.3 are as follows:

- Light-Duty  
Safe Live Load under 2000 lb. (900 kg.)
  - Medium-Duty  
Safe Live Load between 2000 lb. (900 kg.) and 4999 lb. (2250 kg.)
  - Heavy-Duty  
Safe Live Load between 5000 lb. (2250 kg.) and 7499 lb. (3375 kg.)
  - Extra Heavy-Duty  
Safe Live Load between 7500 lb. (3375 kg.) and 10,000 lb. (4500 kg.)
  - Special-Duty  
Safe Live Load over 10,000 lb. (4500 kg.) should be considered special and treated accordingly.
- When the top loading requirements for a drain have been determined, the duty type needed can be resolved. Selection is easily accomplished as all JOSAM Floor Drains are classified according to duty type in this section. For specific detail loading data, contact JOSAM Engineering.

### ADJUSTABLE FLOOR DRAIN ASSEMBLIES

	<b>BODY w/9" ROUND NIKALOY STRAINER</b>	
	<b>LIST PRICE</b>	
	<b>PIPE SIZE</b>	<b>30900-9AD</b>
	<b>2" - 4"</b>	\$2,901.00
	<b>ADD FOR OPTIONS:</b>	





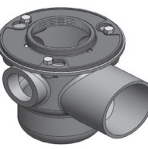

-2 .....	Deduct \$296.00	-TSI .....	POA
-66 (2", 3") .....	313.00	-VP .....	78.00
-66 (4") .....	444.00	-X .....	0.00
-92 .....	280.00	-Y .....	0.00
-T .....	112.00	-Z .....	0.00

	<b>BODY w/5" ROUND NIKALOY TOP</b>	
	<b>LIST PRICE</b>	
	<b>PIPE SIZE</b>	<b>31000</b>
	<b>2" - 4"</b>	\$545.00

<b>ADD FOR OPTIONS:</b>			
-C .....	\$47.00	-Y (2", 3") .....	\$0.00
-SQ .....	233.00	-Z (3", 4") .....	0.00
-TSI .....	POA		

	<b>BODY w/INTEGRAL TRAP AND AUXILIARY INETS</b>	
	<b>LIST PRICE</b>	
	<b>PIPE SIZE</b>	<b>31300</b>
	<b>2" - 4"</b>	\$1,211.00
	<b>ADD FOR OPTIONS:</b>	

-92 .....	\$280.00	-ARE .....	\$249.00
-----------	----------	------------	----------

FLOOR DRAINS																																										
 <p><b>32100</b></p>	<p><b>SUPER-FLO® 9" TOP</b></p> <table border="1"> <thead> <tr> <th colspan="2">LIST PRICE</th> </tr> <tr> <th>PIPE SIZE</th> <th>32100</th> </tr> </thead> <tbody> <tr> <td>2" - 4"</td> <td>\$722.00</td> </tr> <tr> <td>6" (Z)</td> <td>925.00</td> </tr> </tbody> </table> <p><b>ADD FOR OPTIONS:</b></p> <table border="0"> <tr> <td>-1 .....\$719.00</td> <td>-49 .....\$233.00</td> <td>-LC1...\$1,891.00</td> </tr> <tr> <td>-2 .....612.00</td> <td>-50 .....233.00</td> <td>-LC2...1,729.00</td> </tr> <tr> <td>-7 .....336.00</td> <td>-66 .....617.00</td> <td>-PFB.....401.00</td> </tr> <tr> <td>-11 .....92.00</td> <td>-81 .....134.00</td> <td>-T.....112.00</td> </tr> <tr> <td>-13 .....116.00</td> <td>-84 .....414.00</td> <td>-TG.....174.00</td> </tr> <tr> <td>-13-1 ..1,247.00</td> <td>-88 .....60.00</td> <td>-TSI†.....POA</td> </tr> <tr> <td>-13-2 .....996.00</td> <td>-92 .....610.00</td> <td>-VP.....212.00</td> </tr> <tr> <td>-15 .....348.00</td> <td>-AE†.....291.00</td> <td>-X.....0.00</td> </tr> <tr> <td>-39 .....696.00</td> <td>-ARE.....737.00</td> <td>-Y.....0.00</td> </tr> <tr> <td>-44* .....403.00</td> <td>-HP .....153.00</td> <td>-Z (2"- 4") ..0.00</td> </tr> <tr> <td>-44-92* ..820.00</td> <td>-HP-7 .....233.00</td> <td></td> </tr> </table> <p>* Specify Height, Each 3" or Fraction † Available up to 4" only</p>	LIST PRICE		PIPE SIZE	32100	2" - 4"	\$722.00	6" (Z)	925.00	-1 .....\$719.00	-49 .....\$233.00	-LC1...\$1,891.00	-2 .....612.00	-50 .....233.00	-LC2...1,729.00	-7 .....336.00	-66 .....617.00	-PFB.....401.00	-11 .....92.00	-81 .....134.00	-T.....112.00	-13 .....116.00	-84 .....414.00	-TG.....174.00	-13-1 ..1,247.00	-88 .....60.00	-TSI†.....POA	-13-2 .....996.00	-92 .....610.00	-VP.....212.00	-15 .....348.00	-AE†.....291.00	-X.....0.00	-39 .....696.00	-ARE.....737.00	-Y.....0.00	-44* .....403.00	-HP .....153.00	-Z (2"- 4") ..0.00	-44-92* ..820.00	-HP-7 .....233.00	
	LIST PRICE																																									
	PIPE SIZE	32100																																								
	2" - 4"	\$722.00																																								
6" (Z)	925.00																																									
-1 .....\$719.00	-49 .....\$233.00	-LC1...\$1,891.00																																								
-2 .....612.00	-50 .....233.00	-LC2...1,729.00																																								
-7 .....336.00	-66 .....617.00	-PFB.....401.00																																								
-11 .....92.00	-81 .....134.00	-T.....112.00																																								
-13 .....116.00	-84 .....414.00	-TG.....174.00																																								
-13-1 ..1,247.00	-88 .....60.00	-TSI†.....POA																																								
-13-2 .....996.00	-92 .....610.00	-VP.....212.00																																								
-15 .....348.00	-AE†.....291.00	-X.....0.00																																								
-39 .....696.00	-ARE.....737.00	-Y.....0.00																																								
-44* .....403.00	-HP .....153.00	-Z (2"- 4") ..0.00																																								
-44-92* ..820.00	-HP-7 .....233.00																																									
 <p><b>32100-TG</b></p>	<p><b>9" TRACTOR TOP</b></p> <table border="1"> <thead> <tr> <th colspan="2">LIST PRICE</th> </tr> <tr> <th>PIPE SIZE</th> <th>32100-TG</th> </tr> </thead> <tbody> <tr> <td>2" - 4"</td> <td>\$897.00</td> </tr> </tbody> </table> <p><b>ADD FOR OPTIONS:</b></p> <table border="0"> <tr> <td>-1 .....\$719.00</td> <td>-66 .....\$617.00</td> <td>-T.....\$112.00</td> </tr> <tr> <td>-2 .....612.00</td> <td>-81 .....134.00</td> <td>-TSI†.....POA</td> </tr> <tr> <td>-7 .....336.00</td> <td>-84 .....414.00</td> <td>-VP.....212.00</td> </tr> <tr> <td>-15 .....348.00</td> <td>-88 .....60.00</td> <td>-X.....0.00</td> </tr> <tr> <td>-44* .....403.00</td> <td>-92 .....610.00</td> <td>-Y.....0.00</td> </tr> <tr> <td>-44-92* ..820.00</td> <td>-AE.....291.00</td> <td>-Z (2"- 4") ..0.00</td> </tr> <tr> <td>-49 .....233.00</td> <td>-ARE.....737.00</td> <td></td> </tr> <tr> <td>-50 .....233.00</td> <td>-PFB.....401.00</td> <td></td> </tr> </table> <p>* Specify Height, Each 3" or Fraction † Available up to 4" only</p>	LIST PRICE		PIPE SIZE	32100-TG	2" - 4"	\$897.00	-1 .....\$719.00	-66 .....\$617.00	-T.....\$112.00	-2 .....612.00	-81 .....134.00	-TSI†.....POA	-7 .....336.00	-84 .....414.00	-VP.....212.00	-15 .....348.00	-88 .....60.00	-X.....0.00	-44* .....403.00	-92 .....610.00	-Y.....0.00	-44-92* ..820.00	-AE.....291.00	-Z (2"- 4") ..0.00	-49 .....233.00	-ARE.....737.00		-50 .....233.00	-PFB.....401.00												
	LIST PRICE																																									
	PIPE SIZE	32100-TG																																								
	2" - 4"	\$897.00																																								
-1 .....\$719.00	-66 .....\$617.00	-T.....\$112.00																																								
-2 .....612.00	-81 .....134.00	-TSI†.....POA																																								
-7 .....336.00	-84 .....414.00	-VP.....212.00																																								
-15 .....348.00	-88 .....60.00	-X.....0.00																																								
-44* .....403.00	-92 .....610.00	-Y.....0.00																																								
-44-92* ..820.00	-AE.....291.00	-Z (2"- 4") ..0.00																																								
-49 .....233.00	-ARE.....737.00																																									
-50 .....233.00	-PFB.....401.00																																									
 <p><b>32150</b></p>	<p><b>SUPER-FLO® 9" BLOOD DRAIN</b></p> <table border="1"> <thead> <tr> <th colspan="2">LIST PRICE</th> </tr> <tr> <th>PIPE SIZE</th> <th>32150</th> </tr> </thead> <tbody> <tr> <td>2" - 4"</td> <td>\$2,162.00</td> </tr> </tbody> </table> <p><b>ADD FOR OPTIONS:</b></p> <table border="0"> <tr> <td>-1 .....\$3,967.00</td> <td>-ARE.....\$1,481.00</td> </tr> <tr> <td>-2 .....3,207.00</td> <td>-T.....112.00</td> </tr> <tr> <td>-7 .....780.00</td> <td>-TSI .....POA</td> </tr> <tr> <td>-44* .....527.00</td> <td>-X.....0.00</td> </tr> <tr> <td>-44-92* .....1,200.00</td> <td>-Y.....0.00</td> </tr> <tr> <td>-92 .....1,213.00</td> <td>-Z.....0.00</td> </tr> </table> <p>* Specify Height, Each 3" or Fraction</p>	LIST PRICE		PIPE SIZE	32150	2" - 4"	\$2,162.00	-1 .....\$3,967.00	-ARE.....\$1,481.00	-2 .....3,207.00	-T.....112.00	-7 .....780.00	-TSI .....POA	-44* .....527.00	-X.....0.00	-44-92* .....1,200.00	-Y.....0.00	-92 .....1,213.00	-Z.....0.00																							
	LIST PRICE																																									
	PIPE SIZE	32150																																								
	2" - 4"	\$2,162.00																																								
-1 .....\$3,967.00	-ARE.....\$1,481.00																																									
-2 .....3,207.00	-T.....112.00																																									
-7 .....780.00	-TSI .....POA																																									
-44* .....527.00	-X.....0.00																																									
-44-92* .....1,200.00	-Y.....0.00																																									
-92 .....1,213.00	-Z.....0.00																																									
 <p><b>32160</b></p>	<p><b>DEEP BODY, 9" TRACTOR TOP</b></p> <table border="1"> <thead> <tr> <th colspan="2">LIST PRICE</th> </tr> <tr> <th>PIPE SIZE</th> <th>32160</th> </tr> </thead> <tbody> <tr> <td>3", 4"</td> <td>\$1,958.00</td> </tr> </tbody> </table> <p><b>ADD FOR OPTIONS:</b></p> <table border="0"> <tr> <td>-7 .....\$270.00</td> <td>-51 .....\$495.00</td> <td>-66 .....\$530.00</td> </tr> <tr> <td>-12 .....462.00</td> <td>-52 .....495.00</td> <td>-71† .....270.00</td> </tr> <tr> <td>-15 .....348.00</td> <td>-53 .....666.00</td> <td>-81† .....270.00</td> </tr> <tr> <td>-19 .....719.00</td> <td>-54 .....666.00</td> <td>-88† .....78.00</td> </tr> <tr> <td>20 .....601.00</td> <td>-53-92....756.00</td> <td>-92 .....805.00</td> </tr> <tr> <td>-44* .....403.00</td> <td>-54-92....756.00</td> <td>-ARE ..1,336.00</td> </tr> <tr> <td>-49 .....213.00</td> <td>-60 .....879.00</td> <td>-HP.....153.00</td> </tr> <tr> <td>-50 .....213.00</td> <td>-62 (3")† .557.00</td> <td>-TSI.....POA</td> </tr> <tr> <td></td> <td>-62 (4")† 943.00</td> <td>-VP.....270.00</td> </tr> <tr> <td></td> <td></td> <td>-X.....0.00</td> </tr> </table> <p>* Specify Height, Each 3" or Fraction † Cannot be installed when BWV is ordered.</p>	LIST PRICE		PIPE SIZE	32160	3", 4"	\$1,958.00	-7 .....\$270.00	-51 .....\$495.00	-66 .....\$530.00	-12 .....462.00	-52 .....495.00	-71† .....270.00	-15 .....348.00	-53 .....666.00	-81† .....270.00	-19 .....719.00	-54 .....666.00	-88† .....78.00	20 .....601.00	-53-92....756.00	-92 .....805.00	-44* .....403.00	-54-92....756.00	-ARE ..1,336.00	-49 .....213.00	-60 .....879.00	-HP.....153.00	-50 .....213.00	-62 (3")† .557.00	-TSI.....POA		-62 (4")† 943.00	-VP.....270.00			-X.....0.00					
	LIST PRICE																																									
	PIPE SIZE	32160																																								
	3", 4"	\$1,958.00																																								
-7 .....\$270.00	-51 .....\$495.00	-66 .....\$530.00																																								
-12 .....462.00	-52 .....495.00	-71† .....270.00																																								
-15 .....348.00	-53 .....666.00	-81† .....270.00																																								
-19 .....719.00	-54 .....666.00	-88† .....78.00																																								
20 .....601.00	-53-92....756.00	-92 .....805.00																																								
-44* .....403.00	-54-92....756.00	-ARE ..1,336.00																																								
-49 .....213.00	-60 .....879.00	-HP.....153.00																																								
-50 .....213.00	-62 (3")† .557.00	-TSI.....POA																																								
	-62 (4")† 943.00	-VP.....270.00																																								
		-X.....0.00																																								
 <p><b>32200</b></p>	<p><b>SHALLOW SUMP, SUPER-FLO® 12" TOP</b></p> <table border="1"> <thead> <tr> <th colspan="2">LIST PRICE</th> </tr> <tr> <th>PIPE SIZE</th> <th>32200</th> </tr> </thead> <tbody> <tr> <td>2" - 6"</td> <td>\$1,507.00</td> </tr> <tr> <td>8"</td> <td>1,909.00</td> </tr> </tbody> </table> <p><b>ADD FOR OPTIONS:</b></p> <table border="0"> <tr> <td>-1 .....\$1,077.00</td> <td>-50 .....\$213.00</td> <td>-SD .....\$134.00</td> </tr> <tr> <td>-2 .....932.00</td> <td>-66 ◊ .....530.00</td> <td>-SD-1 ..1,211.00</td> </tr> <tr> <td>-4* .....268.00</td> <td>-81 .....658.00</td> <td>-SD-2 ..1,067.00</td> </tr> <tr> <td>-7 .....371.00</td> <td>-84 .....601.00</td> <td>-T.....112.00</td> </tr> <tr> <td>-13 .....197.00</td> <td>-88 .....92.00</td> <td>-TSI† .....POA</td> </tr> <tr> <td>-13-1 ..1,780.00</td> <td>-92 .....924.00</td> <td>-VP .....212.00</td> </tr> <tr> <td>-13-2 ..1,526.00</td> <td>-AE.....1,016.00</td> <td>-X.....0.00</td> </tr> <tr> <td>-15 .....340.00</td> <td>-ARE...1,205.00</td> <td>-Y.....0.00</td> </tr> <tr> <td>-44** .....355.00</td> <td>-HP .....153.00</td> <td>-Z.....0.00</td> </tr> <tr> <td>-44-92** 718.00</td> <td>-HP-7 .....233.00</td> <td></td> </tr> <tr> <td>-49 .....213.00</td> <td>-OR.....1,016.00</td> <td></td> </tr> </table> <p>* Available on -AE Only      † Available up to 4" only ** Specify Height, Each 3" or Fraction      ◊ 2"- 6"</p>	LIST PRICE		PIPE SIZE	32200	2" - 6"	\$1,507.00	8"	1,909.00	-1 .....\$1,077.00	-50 .....\$213.00	-SD .....\$134.00	-2 .....932.00	-66 ◊ .....530.00	-SD-1 ..1,211.00	-4* .....268.00	-81 .....658.00	-SD-2 ..1,067.00	-7 .....371.00	-84 .....601.00	-T.....112.00	-13 .....197.00	-88 .....92.00	-TSI† .....POA	-13-1 ..1,780.00	-92 .....924.00	-VP .....212.00	-13-2 ..1,526.00	-AE.....1,016.00	-X.....0.00	-15 .....340.00	-ARE...1,205.00	-Y.....0.00	-44** .....355.00	-HP .....153.00	-Z.....0.00	-44-92** 718.00	-HP-7 .....233.00		-49 .....213.00	-OR.....1,016.00	
	LIST PRICE																																									
	PIPE SIZE	32200																																								
	2" - 6"	\$1,507.00																																								
8"	1,909.00																																									
-1 .....\$1,077.00	-50 .....\$213.00	-SD .....\$134.00																																								
-2 .....932.00	-66 ◊ .....530.00	-SD-1 ..1,211.00																																								
-4* .....268.00	-81 .....658.00	-SD-2 ..1,067.00																																								
-7 .....371.00	-84 .....601.00	-T.....112.00																																								
-13 .....197.00	-88 .....92.00	-TSI† .....POA																																								
-13-1 ..1,780.00	-92 .....924.00	-VP .....212.00																																								
-13-2 ..1,526.00	-AE.....1,016.00	-X.....0.00																																								
-15 .....340.00	-ARE...1,205.00	-Y.....0.00																																								
-44** .....355.00	-HP .....153.00	-Z.....0.00																																								
-44-92** 718.00	-HP-7 .....233.00																																									
-49 .....213.00	-OR.....1,016.00																																									
 <p><b>32300</b></p>	<p><b>MEDIUM SUMP, SUPER-FLO® 12" TOP</b></p> <table border="1"> <thead> <tr> <th colspan="2">LIST PRICE</th> </tr> <tr> <th>PIPE SIZE</th> <th>32300</th> </tr> </thead> <tbody> <tr> <td>2" - 8"</td> <td>\$1,824.00</td> </tr> </tbody> </table> <p><b>ADD FOR OPTIONS:</b></p> <table border="0"> <tr> <td>-1 .....\$1,077.00</td> <td>-49 .....\$213.00</td> <td>-HP .....\$153.00</td> </tr> <tr> <td>-2 .....932.00</td> <td>-50 .....213.00</td> <td>-SD .....223.00</td> </tr> <tr> <td>-7 .....371.00</td> <td>-66** .....530.00</td> <td>-SD-19..2,130.00</td> </tr> <tr> <td>-13 .....197.00</td> <td>-81 .....360.00</td> <td>-SD-20**2,064.00</td> </tr> <tr> <td>-13-1 ..1,780.00</td> <td>-84 .....601.00</td> <td>-TSI† .....POA</td> </tr> <tr> <td>-13-2 ..1,526.00</td> <td>-88 .....92.00</td> <td>-VP .....212.00</td> </tr> <tr> <td>-15 .....340.00</td> <td>-92 .....924.00</td> <td>-X.....0.00</td> </tr> <tr> <td>-44* .....355.00</td> <td>-AE.....1,016.00</td> <td>-Z.....0.00</td> </tr> <tr> <td>-44-92* .718.00</td> <td>-ARE...1,374.00</td> <td></td> </tr> </table> <p>* Specify Height, Each 2" or Fraction      ** 2"- 6" † Available up to 4" only</p>	LIST PRICE		PIPE SIZE	32300	2" - 8"	\$1,824.00	-1 .....\$1,077.00	-49 .....\$213.00	-HP .....\$153.00	-2 .....932.00	-50 .....213.00	-SD .....223.00	-7 .....371.00	-66** .....530.00	-SD-19..2,130.00	-13 .....197.00	-81 .....360.00	-SD-20**2,064.00	-13-1 ..1,780.00	-84 .....601.00	-TSI† .....POA	-13-2 ..1,526.00	-88 .....92.00	-VP .....212.00	-15 .....340.00	-92 .....924.00	-X.....0.00	-44* .....355.00	-AE.....1,016.00	-Z.....0.00	-44-92* .718.00	-ARE...1,374.00									
	LIST PRICE																																									
	PIPE SIZE	32300																																								
	2" - 8"	\$1,824.00																																								
-1 .....\$1,077.00	-49 .....\$213.00	-HP .....\$153.00																																								
-2 .....932.00	-50 .....213.00	-SD .....223.00																																								
-7 .....371.00	-66** .....530.00	-SD-19..2,130.00																																								
-13 .....197.00	-81 .....360.00	-SD-20**2,064.00																																								
-13-1 ..1,780.00	-84 .....601.00	-TSI† .....POA																																								
-13-2 ..1,526.00	-88 .....92.00	-VP .....212.00																																								
-15 .....340.00	-92 .....924.00	-X.....0.00																																								
-44* .....355.00	-AE.....1,016.00	-Z.....0.00																																								
-44-92* .718.00	-ARE...1,374.00																																									
 <p><b>32330</b></p>	<p><b>DEEP SUMP, SUPER-FLO® 12" TOP w/BUCKET</b></p> <table border="1"> <thead> <tr> <th colspan="2">LIST PRICE</th> </tr> <tr> <th>PIPE SIZE</th> <th>32330</th> </tr> </thead> <tbody> <tr> <td>2" - 6"</td> <td>\$2,553.00</td> </tr> <tr> <td>8"</td> <td>2,989.00</td> </tr> </tbody> </table> <p><b>ADD FOR OPTIONS:</b></p> <table border="0"> <tr> <td>-15 .....\$340.00</td> <td>-88 .....\$134.00</td> </tr> <tr> <td>-19 .....1,036.00</td> <td>-92 .....1,721.00</td> </tr> <tr> <td>-20 .....898.00</td> <td>-SD .....0.00</td> </tr> <tr> <td>-49 .....233.00</td> <td>-TSI† .....POA</td> </tr> <tr> <td>-50 .....233.00</td> <td>-VP.....212.00</td> </tr> <tr> <td>-66** .....530.00</td> <td>-X.....0.00</td> </tr> <tr> <td>-70 .....Deduct 434.00</td> <td>-Z.....0.00</td> </tr> <tr> <td>-84 .....583.00</td> <td></td> </tr> </table> <p>* Specify Height, Each 3" or Fraction      ** 2"- 6" † Available up to 4" only</p>	LIST PRICE		PIPE SIZE	32330	2" - 6"	\$2,553.00	8"	2,989.00	-15 .....\$340.00	-88 .....\$134.00	-19 .....1,036.00	-92 .....1,721.00	-20 .....898.00	-SD .....0.00	-49 .....233.00	-TSI† .....POA	-50 .....233.00	-VP.....212.00	-66** .....530.00	-X.....0.00	-70 .....Deduct 434.00	-Z.....0.00	-84 .....583.00																		
	LIST PRICE																																									
	PIPE SIZE	32330																																								
	2" - 6"	\$2,553.00																																								
8"	2,989.00																																									
-15 .....\$340.00	-88 .....\$134.00																																									
-19 .....1,036.00	-92 .....1,721.00																																									
-20 .....898.00	-SD .....0.00																																									
-49 .....233.00	-TSI† .....POA																																									
-50 .....233.00	-VP.....212.00																																									
-66** .....530.00	-X.....0.00																																									
-70 .....Deduct 434.00	-Z.....0.00																																									
-84 .....583.00																																										





	<b>15" EXTRA HEAVY-DUTY TOP</b>	
	<b>LIST PRICE</b>	
	<b>PIPE SIZE</b>	<b>34710</b>
	2", 3", 4" 5", 6" 8"	\$2,239.00 2,654.00 3,168.00
<b>ADD FOR OPTIONS:</b>		
-7.....\$879.00	-88.....\$134.00	-VP.....\$208.00
-15.....340.00	-92.....1,274.00	-X.....0.00
-19.....2,626.00	-AE.....1,016.00	-Y.....0.00
-20.....2,294.00	-ARE.....1,327.00	-Z.....0.00
-49.....213.00	-T.....112.00	
-50.....213.00	-TSI†.....POA	
†Available up to 4" only		

	<b>15" EXTRA HEAVY-DUTY TOP w/BUCKET</b>	
	<b>LIST PRICE</b>	
	<b>PIPE SIZE</b>	<b>34720</b>
	3" - 6"	\$4,199.00
<b>ADD FOR OPTIONS:</b>		
-7.....\$943.00	-50.....\$213.00	-TSI†.....POA
-15.....340.00	-66.....530.00	-VP.....296.00
-19.....2,626.00	-84.....601.00	-X.....0.00
-20.....2,294.00	-88.....134.00	-Z.....0.00
-49.....213.00	-92.....2,820.00	
†Available up to 4" only		

	<b>NON-CLOG 21" ROUND TOP w/BUCKET</b>	
	<b>LIST PRICE</b>	
	<b>PIPE SIZE</b>	<b>34920</b>
	3" - 8"	\$21,883.00
<b>ADD FOR OPTIONS:</b>		
-12.....*POA	-49.....\$213.00	-C.....\$0.00
-12-1.....*POA	-50.....213.00	-T.....112.00
-12-2.....*POA	-66**.....530.00	-TSI†.....*POA
-15.....340.00	-80.....4,014.00	-VP.....296.00
-19.....2,816.00	-84.....805.00	-X.....0.00
-20.....2,349.00	-92.....4,213.00	
* PRICE ON APPLICATION    † Available up to 4" only		
** 2" - 6"		









	<b>8" SQUARE TOP</b>	
	<b>LIST PRICE</b>	
	<b>PIPE SIZE</b>	<b>35100</b>
	2" - 4"	\$1,182.00
<b>ADD FOR OPTIONS:</b>		
-1.....\$879.00	-50.....STD	-TSO.....\$313.00
-2.....652.00	-92.....603.00	-X.....0.00
-7.....299.00	-ARE.....719.00	-Y.....0.00
-15.....340.00	-T.....112.00	-Z.....0.00
-49.....233.00	-TSI.....POA	







	<b>9" TOP w/BUCKET</b>	
	<b>LIST PRICE</b>	
	<b>PIPE SIZE</b>	<b>35130</b>
	2" - 4"	\$1,380.00
<b>ADD FOR OPTIONS:</b>		
-1.....\$898.00	-50.....\$213.00	-ARE..\$1,051.00
-2.....652.00	-66.....223.00	-TSI.....POA
-14-1..2,359.00	-70.....Deduct	-VP.....213.00
-14-2..2,231.00	112.00	-X.....0.00
-15.....348.00	-84.....296.00	-Z.....0.00
-49.....213.00	-92.....608.00	





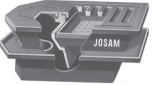

	<b>10" TRACTOR TOP w/BUCKET</b>	
	<b>LIST PRICE</b>	
	<b>PIPE SIZE</b>	<b>35170</b>
	3" - 4"	\$1,658.00
<b>ADD FOR OPTIONS:</b>		
-1.....\$1,380.00	-70Deduct 138.00	-VP.....\$213.00
-2.....1,162.00	-84.....391.00	-X.....0.00
-15.....340.00	-88.....78.00	-Z.....0.00
-49.....233.00	-92.....492.00	
-50.....233.00	-TSI.....POA	

### Option Descriptions

- AE LEVELEZE® Adjustable Extension
  - ARE Acid Resisting Epoxy
  - C Bolted Flashing Clamp Device
  - HP Heel-Proof Grate
  - HP-7 Heel-Proof Grate, Ductile Iron
  - LC1 Locking Cover, Satin Finish Nikaloy
  - LC2 Locking Cover, Satin Finish Bronze
  - LT Less Shallow Trap
  - OR LEVELEZE® Adjustable Extension with O-Ring
  - PFB Pre-Fabricated Base
  - SD Special Duty Grate
  - SD-19 Special Duty, C.I. Undergrate with Satin Finish Nikaloy Top
  - SD-20 Special Duty, C.I. Undergrate with Satin Finish Bronze Top
  - SQ Square Top
  - TG Tractor Grate
  - TSI Trap Seal Insert
  - VP Secured Grate, Vandal-Proof Screws
  - 1 Satin Finish Nikaloy Top
  - 2 Satin Finish Bronze Top
  - 4 Secondary Flashing Clamp (use with -AE only)
  - 7 Ductile Iron Grate
  - 11 Extra-Heavy Grate, Cast Iron
  - 12 Square Top, Cast Iron
  - 12-1 Square Top, Nikaloy
  - 12-2 Square Top, Bronze
  - 13 Dome Grate, Cast Iron
  - 13-1 Dome Grate, Nikaloy
  - 13-2 Dome Grate, Bronze
  - 14-1 Hinged Top, Satin Finish Nikaloy
  - 14-2 Hinged Top, Satin Finish Bronze
  - 15 Chained Grate
  - 19 C.I. Undergrate with Satin Finish Nikaloy Top
  - 20 C.I. Undergrate with Satin Finish Bronze Top
  - 39 Solid Cast Iron Cover
  - 44 Fixed Extension Collar, Cast Iron, Specify Height
  - 44-92 Fixed Extension Collar, Galvanized, Specify Height
  - 49 3/4" Primer Tap
  - 50 1/2" Primer Tap
  - 51 1-1/2" Auxiliary Threaded Inlet
  - 52 2" Auxiliary Threaded Inlet
  - 53 2" Auxiliary Hub Inlet
  - 54 2" Auxiliary Spigot Inlet
  - 53-92 2" Auxiliary Hub Inlet, Galvanized
  - 54-92 2" Auxiliary Spigot Inlet, Galvanized
  - 60 Backwater Valve
  - 62 "T" Handle Bronze Closure Plug
  - 70 Less Bucket
  - 71 Solid Cast Iron Bucket
  - 80 Perforated Stainless Steel Basket
  - 81 Slotted Cast Iron Bucket
  - 84 Stainless Steel Mesh Bucket Liner
  - 88 Supplementary Strainer
  - 92 Galvanized Cast Iron Parts
- Outlets
- 66 No-Hub Side Outlet
  - T Threaded Outlet
  - TSO Threaded Side Outlet
  - X Inside Caulk Outlet
  - Y Hub Outlet with Gasket, 2" - 4"
  - Z No-Hub Outlet

<p><b>37800</b></p> 	<p><b>SHALLOW SUMP, 12" HEAVY-DUTY TOP</b></p> <table border="1"> <thead> <tr> <th colspan="2">LIST PRICE</th> </tr> </thead> <tbody> <tr> <td>PIPE SIZE</td> <td><b>37800</b></td> </tr> <tr> <td>2" - 4"</td> <td>\$2,007.00</td> </tr> </tbody> </table> <p>ADD FOR OPTIONS:</p> <table> <tr> <td>-7 .....\$839.00</td> <td>-49 .....\$233.00</td> <td>-TSI† .....POA</td> </tr> <tr> <td>-14 .....340.00</td> <td>-50 .....STD</td> <td>-VP .....208.00</td> </tr> <tr> <td>-18 .....786.00</td> <td>-66 .....308.00</td> <td>-X.....0.00</td> </tr> <tr> <td>-19 .....1,574.00</td> <td>-92 .....707.00</td> <td>-Y.....0.00</td> </tr> <tr> <td>-20 .....1,302.00</td> <td>-T.....112.00</td> <td>-Z.....0.00</td> </tr> </table>	LIST PRICE		PIPE SIZE	<b>37800</b>	2" - 4"	\$2,007.00	-7 .....\$839.00	-49 .....\$233.00	-TSI† .....POA	-14 .....340.00	-50 .....STD	-VP .....208.00	-18 .....786.00	-66 .....308.00	-X.....0.00	-19 .....1,574.00	-92 .....707.00	-Y.....0.00	-20 .....1,302.00	-T.....112.00	-Z.....0.00	<p><b>37900</b></p> 	<p><b>14" PACKING HOUSE DRAIN</b></p> <table border="1"> <thead> <tr> <th colspan="2">LIST PRICE</th> </tr> </thead> <tbody> <tr> <td>PIPE SIZE</td> <td><b>37900</b></td> </tr> <tr> <td>2" - 6"</td> <td>\$4,238.00</td> </tr> <tr> <td>8"</td> <td>4,778.00</td> </tr> </tbody> </table> <p>ADD FOR OPTIONS:</p> <table> <tr> <td>-4 .....\$268.00</td> <td>-84 .....\$601.00</td> <td>-VP.....\$212.00</td> </tr> <tr> <td>-15 .....348.00</td> <td>-88 .....110.00</td> <td>-X.....0.00</td> </tr> <tr> <td>-19 .....1,926.00</td> <td>-92 .....2,426.00</td> <td>-Y.....0.00</td> </tr> <tr> <td>-20 .....1,833.00</td> <td>-T.....112.00</td> <td>-Z.....0.00</td> </tr> <tr> <td>-70 Ded. 260.00</td> <td>-TSI† .....POA</td> <td></td> </tr> </table> <p>†Available up to 4" only</p>	LIST PRICE		PIPE SIZE	<b>37900</b>	2" - 6"	\$4,238.00	8"	4,778.00	-4 .....\$268.00	-84 .....\$601.00	-VP.....\$212.00	-15 .....348.00	-88 .....110.00	-X.....0.00	-19 .....1,926.00	-92 .....2,426.00	-Y.....0.00	-20 .....1,833.00	-T.....112.00	-Z.....0.00	-70 Ded. 260.00	-TSI† .....POA															
LIST PRICE																																																													
PIPE SIZE	<b>37800</b>																																																												
2" - 4"	\$2,007.00																																																												
-7 .....\$839.00	-49 .....\$233.00	-TSI† .....POA																																																											
-14 .....340.00	-50 .....STD	-VP .....208.00																																																											
-18 .....786.00	-66 .....308.00	-X.....0.00																																																											
-19 .....1,574.00	-92 .....707.00	-Y.....0.00																																																											
-20 .....1,302.00	-T.....112.00	-Z.....0.00																																																											
LIST PRICE																																																													
PIPE SIZE	<b>37900</b>																																																												
2" - 6"	\$4,238.00																																																												
8"	4,778.00																																																												
-4 .....\$268.00	-84 .....\$601.00	-VP.....\$212.00																																																											
-15 .....348.00	-88 .....110.00	-X.....0.00																																																											
-19 .....1,926.00	-92 .....2,426.00	-Y.....0.00																																																											
-20 .....1,833.00	-T.....112.00	-Z.....0.00																																																											
-70 Ded. 260.00	-TSI† .....POA																																																												
<p><b>37810</b></p> 	<p><b>MEDIUM SUMP, 12" HEAVY-DUTY TOP</b></p> <table border="1"> <thead> <tr> <th colspan="2">LIST PRICE</th> </tr> </thead> <tbody> <tr> <td>PIPE SIZE</td> <td><b>37810</b></td> </tr> <tr> <td>2" - 6"</td> <td>\$2,134.00</td> </tr> </tbody> </table> <p>ADD FOR OPTIONS:</p> <table> <tr> <td>-4* .....\$268.00</td> <td>-49 .....\$213.00</td> <td>-AE... \$1,016.00</td> </tr> <tr> <td>-7 .....863.00</td> <td>-50 .....213.00</td> <td>-ARE... 1,319.00</td> </tr> <tr> <td>-14 .....340.00</td> <td>-66 .....530.00</td> <td>-T.....112.00</td> </tr> <tr> <td>-18 .....786.00</td> <td>-70Ded. 237.00</td> <td>-TSI† .....POA</td> </tr> <tr> <td>-19 .....1,574.00</td> <td>-84 .....601.00</td> <td>-VP .....208.00</td> </tr> <tr> <td>-20 .....1,302.00</td> <td>-88 .....134.00</td> <td>-X.....0.00</td> </tr> <tr> <td>-39 .....594.00</td> <td>-92 .....1,274.00</td> <td>-Y.....0.00</td> </tr> <tr> <td></td> <td></td> <td>-Z.....0.00</td> </tr> </table> <p>* Available on -AE only      †Available up to 4" only</p>	LIST PRICE		PIPE SIZE	<b>37810</b>	2" - 6"	\$2,134.00	-4* .....\$268.00	-49 .....\$213.00	-AE... \$1,016.00	-7 .....863.00	-50 .....213.00	-ARE... 1,319.00	-14 .....340.00	-66 .....530.00	-T.....112.00	-18 .....786.00	-70Ded. 237.00	-TSI† .....POA	-19 .....1,574.00	-84 .....601.00	-VP .....208.00	-20 .....1,302.00	-88 .....134.00	-X.....0.00	-39 .....594.00	-92 .....1,274.00	-Y.....0.00			-Z.....0.00	<p><b>37960</b></p> 	<p><b>SUPER-FLO® 16" TOP</b></p> <table border="1"> <thead> <tr> <th colspan="2">LIST PRICE</th> </tr> </thead> <tbody> <tr> <td>PIPE SIZE</td> <td><b>37960</b></td> </tr> <tr> <td>2" - 6"</td> <td>\$3,647.00</td> </tr> </tbody> </table> <p>ADD FOR OPTIONS:</p> <table> <tr> <td>-1 .....\$4,221.00</td> <td>-81 .....\$842.00</td> <td>-LF...Ded. \$532.00</td> </tr> <tr> <td>-2 .....3,793.00</td> <td>-84 .....601.00</td> <td>-LG...Ded. 810.00</td> </tr> <tr> <td>-7 .....872.00</td> <td>-92 .....1,803.00</td> <td>-LG-1Ded. 1,693.00</td> </tr> <tr> <td>-11 .....872.00</td> <td>-92-LF... 1,515.00</td> <td>-LG-2Ded. 1,577.00</td> </tr> <tr> <td>-15 .....348.00</td> <td>-92-LG-LF 1,380.00</td> <td>-TSI† .....POA</td> </tr> <tr> <td>-49 .....270.00</td> <td>-ARE...See 49400</td> <td>-VP* .....110.00</td> </tr> <tr> <td>-50 .....270.00</td> <td>-C.....805.00</td> <td>-X.....0.00</td> </tr> </table> <p>†Available up to 4" only      *Only available with -1 or -2</p>	LIST PRICE		PIPE SIZE	<b>37960</b>	2" - 6"	\$3,647.00	-1 .....\$4,221.00	-81 .....\$842.00	-LF...Ded. \$532.00	-2 .....3,793.00	-84 .....601.00	-LG...Ded. 810.00	-7 .....872.00	-92 .....1,803.00	-LG-1Ded. 1,693.00	-11 .....872.00	-92-LF... 1,515.00	-LG-2Ded. 1,577.00	-15 .....348.00	-92-LG-LF 1,380.00	-TSI† .....POA	-49 .....270.00	-ARE...See 49400	-VP* .....110.00	-50 .....270.00	-C.....805.00	-X.....0.00	
LIST PRICE																																																													
PIPE SIZE	<b>37810</b>																																																												
2" - 6"	\$2,134.00																																																												
-4* .....\$268.00	-49 .....\$213.00	-AE... \$1,016.00																																																											
-7 .....863.00	-50 .....213.00	-ARE... 1,319.00																																																											
-14 .....340.00	-66 .....530.00	-T.....112.00																																																											
-18 .....786.00	-70Ded. 237.00	-TSI† .....POA																																																											
-19 .....1,574.00	-84 .....601.00	-VP .....208.00																																																											
-20 .....1,302.00	-88 .....134.00	-X.....0.00																																																											
-39 .....594.00	-92 .....1,274.00	-Y.....0.00																																																											
		-Z.....0.00																																																											
LIST PRICE																																																													
PIPE SIZE	<b>37960</b>																																																												
2" - 6"	\$3,647.00																																																												
-1 .....\$4,221.00	-81 .....\$842.00	-LF...Ded. \$532.00																																																											
-2 .....3,793.00	-84 .....601.00	-LG...Ded. 810.00																																																											
-7 .....872.00	-92 .....1,803.00	-LG-1Ded. 1,693.00																																																											
-11 .....872.00	-92-LF... 1,515.00	-LG-2Ded. 1,577.00																																																											
-15 .....348.00	-92-LG-LF 1,380.00	-TSI† .....POA																																																											
-49 .....270.00	-ARE...See 49400	-VP* .....110.00																																																											
-50 .....270.00	-C.....805.00	-X.....0.00																																																											
<p><b>37820</b></p> 	<p><b>DEEP SUMP, 12" HEAVY-DUTY TOP w/BUCKET</b></p> <table border="1"> <thead> <tr> <th colspan="2">LIST PRICE</th> </tr> </thead> <tbody> <tr> <td>PIPE SIZE</td> <td><b>37820</b></td> </tr> <tr> <td>2" - 8"</td> <td>\$2,452.00</td> </tr> </tbody> </table> <p>ADD FOR OPTIONS:</p> <table> <tr> <td>-4* .....\$268.00</td> <td>-49 .....\$213.00</td> <td>-AE... \$1,016.00</td> </tr> <tr> <td>-7 .....863.00</td> <td>-50 .....213.00</td> <td>-ARE... 1,394.00</td> </tr> <tr> <td>-14 .....340.00</td> <td>-66**.....530.00</td> <td>-TSI† .....POA</td> </tr> <tr> <td>-18 .....786.00</td> <td>-70Ded. 237.00</td> <td>-VP .....208.00</td> </tr> <tr> <td>-19 .....1,574.00</td> <td>-84 .....601.00</td> <td>-X.....0.00</td> </tr> <tr> <td>-20 .....1,302.00</td> <td>-88 .....134.00</td> <td>-Z.....0.00</td> </tr> <tr> <td>-39 .....594.00</td> <td>-92 .....1,274.00</td> <td></td> </tr> </table> <p>* Available on -AE only      †Available up to 4" only ** 2" - 6"</p>	LIST PRICE		PIPE SIZE	<b>37820</b>	2" - 8"	\$2,452.00	-4* .....\$268.00	-49 .....\$213.00	-AE... \$1,016.00	-7 .....863.00	-50 .....213.00	-ARE... 1,394.00	-14 .....340.00	-66**.....530.00	-TSI† .....POA	-18 .....786.00	-70Ded. 237.00	-VP .....208.00	-19 .....1,574.00	-84 .....601.00	-X.....0.00	-20 .....1,302.00	-88 .....134.00	-Z.....0.00	-39 .....594.00	-92 .....1,274.00		<p><b>38040</b></p> 	<p><b>ROUND TOP &amp; CLEANOUT</b></p> <table border="1"> <thead> <tr> <th colspan="2">LIST PRICE</th> </tr> </thead> <tbody> <tr> <td>PIPE SIZE</td> <td><b>38040</b></td> </tr> <tr> <td>2"</td> <td>\$1,800.00</td> </tr> <tr> <td>3"</td> <td>2,829.00</td> </tr> <tr> <td>4"</td> <td>2,972.00</td> </tr> </tbody> </table> <p>ADD FOR OPTIONS:</p> <table> <tr> <td>-1 .....\$1,094.00</td> <td>-51 .....\$495.00</td> <td>-81-92 \$299.00</td> </tr> <tr> <td>-2 .....1,001.00</td> <td>-52 .....495.00</td> <td>-84 .....414.00</td> </tr> <tr> <td>-7 .....360.00</td> <td>-60* (2") 860.00</td> <td>-88 .....60.00</td> </tr> <tr> <td>-11 .....92.00</td> <td>-60* (3") 949.00</td> <td>-92 .....1,077.00</td> </tr> <tr> <td>-15 .....336.00</td> <td>-60* (4").....</td> <td>-TSI .....POA</td> </tr> <tr> <td>-49 .....213.00</td> <td>1,036.00</td> <td>-VP .....208.00</td> </tr> <tr> <td>-50 .....213.00</td> <td>-81 .....177.00</td> <td>-Z.....0.00</td> </tr> </table> <p>Note: When ordering/using a -81 option, the -7 and -11 options can not be used. *Can not be used with TSI</p>	LIST PRICE		PIPE SIZE	<b>38040</b>	2"	\$1,800.00	3"	2,829.00	4"	2,972.00	-1 .....\$1,094.00	-51 .....\$495.00	-81-92 \$299.00	-2 .....1,001.00	-52 .....495.00	-84 .....414.00	-7 .....360.00	-60* (2") 860.00	-88 .....60.00	-11 .....92.00	-60* (3") 949.00	-92 .....1,077.00	-15 .....336.00	-60* (4").....	-TSI .....POA	-49 .....213.00	1,036.00	-VP .....208.00	-50 .....213.00	-81 .....177.00	-Z.....0.00
LIST PRICE																																																													
PIPE SIZE	<b>37820</b>																																																												
2" - 8"	\$2,452.00																																																												
-4* .....\$268.00	-49 .....\$213.00	-AE... \$1,016.00																																																											
-7 .....863.00	-50 .....213.00	-ARE... 1,394.00																																																											
-14 .....340.00	-66**.....530.00	-TSI† .....POA																																																											
-18 .....786.00	-70Ded. 237.00	-VP .....208.00																																																											
-19 .....1,574.00	-84 .....601.00	-X.....0.00																																																											
-20 .....1,302.00	-88 .....134.00	-Z.....0.00																																																											
-39 .....594.00	-92 .....1,274.00																																																												
LIST PRICE																																																													
PIPE SIZE	<b>38040</b>																																																												
2"	\$1,800.00																																																												
3"	2,829.00																																																												
4"	2,972.00																																																												
-1 .....\$1,094.00	-51 .....\$495.00	-81-92 \$299.00																																																											
-2 .....1,001.00	-52 .....495.00	-84 .....414.00																																																											
-7 .....360.00	-60* (2") 860.00	-88 .....60.00																																																											
-11 .....92.00	-60* (3") 949.00	-92 .....1,077.00																																																											
-15 .....336.00	-60* (4").....	-TSI .....POA																																																											
-49 .....213.00	1,036.00	-VP .....208.00																																																											
-50 .....213.00	-81 .....177.00	-Z.....0.00																																																											
<p><b>37830</b></p> 	<p><b>12" TOP w/LATCHING GRATE</b></p> <table border="1"> <thead> <tr> <th colspan="2">LIST PRICE</th> </tr> </thead> <tbody> <tr> <td>PIPE SIZE</td> <td><b>37830</b></td> </tr> <tr> <td>2" - 6"</td> <td>\$2,922.00</td> </tr> </tbody> </table> <p>ADD FOR OPTIONS:</p> <table> <tr> <td>-7 .....\$863.00</td> <td>-39 .....\$594.00</td> <td>-84 .....\$601.00</td> </tr> <tr> <td>-19 .....1,574.00</td> <td>-49 .....213.00</td> <td>-92 .....1,274.00</td> </tr> <tr> <td>-20 .....1,302.00</td> <td>-50 .....213.00</td> <td>-TSI† .....POA</td> </tr> <tr> <td>-21 Ded. 671.00</td> <td>-66 .....530.00</td> <td>-X.....0.00</td> </tr> <tr> <td>-22 Ded. 444.00</td> <td>-69 .....112.00</td> <td>-Z.....0.00</td> </tr> </table> <p>†Available up to 4" only</p>	LIST PRICE		PIPE SIZE	<b>37830</b>	2" - 6"	\$2,922.00	-7 .....\$863.00	-39 .....\$594.00	-84 .....\$601.00	-19 .....1,574.00	-49 .....213.00	-92 .....1,274.00	-20 .....1,302.00	-50 .....213.00	-TSI† .....POA	-21 Ded. 671.00	-66 .....530.00	-X.....0.00	-22 Ded. 444.00	-69 .....112.00	-Z.....0.00	<p><b>38250A</b></p> 	<p><b>ROUND TOP w/CLEANOUT &amp; BWV</b></p> <table border="1"> <thead> <tr> <th colspan="2">LIST PRICE</th> </tr> </thead> <tbody> <tr> <td>PIPE SIZE</td> <td><b>38250A</b></td> </tr> <tr> <td>2"</td> <td>\$1,213.00</td> </tr> <tr> <td>3"</td> <td>1,662.00</td> </tr> <tr> <td>4"</td> <td>2,337.00</td> </tr> </tbody> </table> <p>ADD FOR OPTIONS:</p> <table> <tr> <td>-1 (2" - 3").....\$591.00</td> <td>-61 (2")....Deduct \$134.00</td> </tr> <tr> <td>-1 (4").....1,394.00</td> <td>-61 (3", 4")..Deduct 273.00</td> </tr> <tr> <td>-2 (2" - 3").....532.00</td> <td>-92 .....699.00</td> </tr> <tr> <td>-2 (4").....1,259.00</td> <td>-VP.....208.00</td> </tr> <tr> <td>-15 .....340.00</td> <td>-Z .....0.00</td> </tr> </table>	LIST PRICE		PIPE SIZE	<b>38250A</b>	2"	\$1,213.00	3"	1,662.00	4"	2,337.00	-1 (2" - 3").....\$591.00	-61 (2")....Deduct \$134.00	-1 (4").....1,394.00	-61 (3", 4")..Deduct 273.00	-2 (2" - 3").....532.00	-92 .....699.00	-2 (4").....1,259.00	-VP.....208.00	-15 .....340.00	-Z .....0.00																	
LIST PRICE																																																													
PIPE SIZE	<b>37830</b>																																																												
2" - 6"	\$2,922.00																																																												
-7 .....\$863.00	-39 .....\$594.00	-84 .....\$601.00																																																											
-19 .....1,574.00	-49 .....213.00	-92 .....1,274.00																																																											
-20 .....1,302.00	-50 .....213.00	-TSI† .....POA																																																											
-21 Ded. 671.00	-66 .....530.00	-X.....0.00																																																											
-22 Ded. 444.00	-69 .....112.00	-Z.....0.00																																																											
LIST PRICE																																																													
PIPE SIZE	<b>38250A</b>																																																												
2"	\$1,213.00																																																												
3"	1,662.00																																																												
4"	2,337.00																																																												
-1 (2" - 3").....\$591.00	-61 (2")....Deduct \$134.00																																																												
-1 (4").....1,394.00	-61 (3", 4")..Deduct 273.00																																																												
-2 (2" - 3").....532.00	-92 .....699.00																																																												
-2 (4").....1,259.00	-VP.....208.00																																																												
-15 .....340.00	-Z .....0.00																																																												
<p><b>37840</b></p> 	<p><b>12" TOP w/BUCKET</b></p> <table border="1"> <thead> <tr> <th colspan="2">LIST PRICE</th> </tr> </thead> <tbody> <tr> <td>PIPE SIZE</td> <td><b>37840</b></td> </tr> <tr> <td>2" - 8"</td> <td>\$4,238.00</td> </tr> </tbody> </table> <p>ADD FOR OPTIONS:</p> <table> <tr> <td>-7 .....\$863.00</td> <td>-50 .....\$213.00</td> <td>-TSI† .....POA</td> </tr> <tr> <td>-14 .....340.00</td> <td>-66* .....530.00</td> <td>-VP .....208.00</td> </tr> <tr> <td>-19 .....1,574.00</td> <td>-70 Ded. 237.00</td> <td>-X.....0.00</td> </tr> <tr> <td>-20 .....1,302.00</td> <td>-84 .....601.00</td> <td>-Z.....0.00</td> </tr> <tr> <td>-39 .....594.00</td> <td>-88 .....134.00</td> <td></td> </tr> <tr> <td>-49 .....213.00</td> <td>-92 .....1,274.00</td> <td></td> </tr> </table> <p>* 2" - 6"      †Available up to 4" only</p>	LIST PRICE		PIPE SIZE	<b>37840</b>	2" - 8"	\$4,238.00	-7 .....\$863.00	-50 .....\$213.00	-TSI† .....POA	-14 .....340.00	-66* .....530.00	-VP .....208.00	-19 .....1,574.00	-70 Ded. 237.00	-X.....0.00	-20 .....1,302.00	-84 .....601.00	-Z.....0.00	-39 .....594.00	-88 .....134.00		-49 .....213.00	-92 .....1,274.00																																					
LIST PRICE																																																													
PIPE SIZE	<b>37840</b>																																																												
2" - 8"	\$4,238.00																																																												
-7 .....\$863.00	-50 .....\$213.00	-TSI† .....POA																																																											
-14 .....340.00	-66* .....530.00	-VP .....208.00																																																											
-19 .....1,574.00	-70 Ded. 237.00	-X.....0.00																																																											
-20 .....1,302.00	-84 .....601.00	-Z.....0.00																																																											
-39 .....594.00	-88 .....134.00																																																												
-49 .....213.00	-92 .....1,274.00																																																												

 <p><b>38420</b></p>	<p><b>NON-CLOG w/CLEANOUT &amp; BUCKET</b></p> <table border="1"> <thead> <tr> <th colspan="2">LIST PRICE</th> </tr> </thead> <tbody> <tr> <td>PIPE SIZE</td> <td><b>38420</b></td> </tr> <tr> <td>3", 4"</td> <td>\$22,893.00</td> </tr> </tbody> </table> <p><b>ADD FOR OPTIONS:</b></p> <table> <tr> <td>-1 .....</td> <td>\$5,717.00</td> <td>-92 .....</td> <td>\$4,974.00</td> </tr> <tr> <td>-2 .....</td> <td>5,142.00</td> <td>-C .....</td> <td>761.00</td> </tr> <tr> <td>-15 .....</td> <td>348.00</td> <td>-IGS .....</td> <td>27,256.00</td> </tr> <tr> <td>-60 .....</td> <td>1,394.00</td> <td>-VP .....</td> <td>340.00</td> </tr> <tr> <td>-84 .....</td> <td>601.00</td> <td></td> <td></td> </tr> </table>	LIST PRICE		PIPE SIZE	<b>38420</b>	3", 4"	\$22,893.00	-1 .....	\$5,717.00	-92 .....	\$4,974.00	-2 .....	5,142.00	-C .....	761.00	-15 .....	348.00	-IGS .....	27,256.00	-60 .....	1,394.00	-VP .....	340.00	-84 .....	601.00			 <p><b>38850</b></p> <p><b>22" x 14" TOP, INTERNAL DOME STRAINER</b></p> <table border="1"> <thead> <tr> <th colspan="2">LIST PRICE</th> </tr> </thead> <tbody> <tr> <td>PIPE SIZE</td> <td><b>38850</b></td> </tr> <tr> <td>3" - 6"</td> <td>\$8,802.00</td> </tr> </tbody> </table> <p><b>ADD FOR OPTIONS:</b></p> <table> <tr> <td>-7 .....</td> <td>\$2,829.00</td> <td>-TSI† .....</td> <td>POA</td> </tr> <tr> <td>-15 .....</td> <td>348.00</td> <td>-VP .....</td> <td>340.00</td> </tr> <tr> <td>-92 .....</td> <td>4,721.00</td> <td>-X .....</td> <td>0.00</td> </tr> </table> <p>†Available up to 4" only</p>	LIST PRICE		PIPE SIZE	<b>38850</b>	3" - 6"	\$8,802.00	-7 .....	\$2,829.00	-TSI† .....	POA	-15 .....	348.00	-VP .....	340.00	-92 .....	4,721.00	-X .....	0.00																
LIST PRICE																																																														
PIPE SIZE	<b>38420</b>																																																													
3", 4"	\$22,893.00																																																													
-1 .....	\$5,717.00	-92 .....	\$4,974.00																																																											
-2 .....	5,142.00	-C .....	761.00																																																											
-15 .....	348.00	-IGS .....	27,256.00																																																											
-60 .....	1,394.00	-VP .....	340.00																																																											
-84 .....	601.00																																																													
LIST PRICE																																																														
PIPE SIZE	<b>38850</b>																																																													
3" - 6"	\$8,802.00																																																													
-7 .....	\$2,829.00	-TSI† .....	POA																																																											
-15 .....	348.00	-VP .....	340.00																																																											
-92 .....	4,721.00	-X .....	0.00																																																											
 <p><b>38620-40</b></p>	<p><b>13" X 11" TOP w/HINGED GRATE</b></p> <table border="1"> <thead> <tr> <th colspan="2">LIST PRICE</th> </tr> </thead> <tbody> <tr> <td>PIPE SIZE</td> <td><b>38620-40</b></td> </tr> <tr> <td>3"</td> <td>\$7,012.00</td> </tr> <tr> <td>4"</td> <td>7,731.00</td> </tr> </tbody> </table> <p><b>ADD FOR OPTIONS:</b></p> <table> <tr> <td>-1 (3")</td> <td>\$2,104.00</td> <td>-33 .....</td> <td>\$530.00</td> <td>-70 Ded.</td> <td>\$237.00</td> </tr> <tr> <td>-1 (4")</td> <td>2,290.00</td> <td>-49 .....</td> <td>213.00</td> <td>-84 .....</td> <td>601.00</td> </tr> <tr> <td>-2 (3")</td> <td>1,707.00</td> <td>-50 .....</td> <td>213.00</td> <td>-92 .....</td> <td>2,735.00</td> </tr> <tr> <td>-2 (4")</td> <td>1,884.00</td> <td>-60* (3")</td> <td>953.00</td> <td>-TSI .....</td> <td>POA</td> </tr> <tr> <td>-7 .....</td> <td>872.00</td> <td>-60* (4")</td> <td>1,038.00</td> <td>-VP .....</td> <td>208.00</td> </tr> </table> <p>*Can not be used with TSI</p>	LIST PRICE		PIPE SIZE	<b>38620-40</b>	3"	\$7,012.00	4"	7,731.00	-1 (3")	\$2,104.00	-33 .....	\$530.00	-70 Ded.	\$237.00	-1 (4")	2,290.00	-49 .....	213.00	-84 .....	601.00	-2 (3")	1,707.00	-50 .....	213.00	-92 .....	2,735.00	-2 (4")	1,884.00	-60* (3")	953.00	-TSI .....	POA	-7 .....	872.00	-60* (4")	1,038.00	-VP .....	208.00	 <p><b>38930</b></p> <p><b>21" x 14 1/2" TOP, CLEANOUT &amp; BUCKET</b></p> <table border="1"> <thead> <tr> <th colspan="2">LIST PRICE</th> </tr> </thead> <tbody> <tr> <td>PIPE SIZE</td> <td><b>38930</b></td> </tr> <tr> <td>3", 4"</td> <td>\$5,094.00</td> </tr> </tbody> </table> <p><b>ADD FOR OPTIONS:</b></p> <table> <tr> <td>-7 .....</td> <td>\$879.00</td> <td>-C .....</td> <td>\$560.00</td> </tr> <tr> <td>-15 .....</td> <td>348.00</td> <td>-VP .....</td> <td>212.00</td> </tr> <tr> <td>-84 .....</td> <td>601.00</td> <td>-X .....</td> <td>0.00</td> </tr> <tr> <td>-92 .....</td> <td>2,291.00</td> <td></td> <td></td> </tr> </table>	LIST PRICE		PIPE SIZE	<b>38930</b>	3", 4"	\$5,094.00	-7 .....	\$879.00	-C .....	\$560.00	-15 .....	348.00	-VP .....	212.00	-84 .....	601.00	-X .....	0.00	-92 .....	2,291.00		
LIST PRICE																																																														
PIPE SIZE	<b>38620-40</b>																																																													
3"	\$7,012.00																																																													
4"	7,731.00																																																													
-1 (3")	\$2,104.00	-33 .....	\$530.00	-70 Ded.	\$237.00																																																									
-1 (4")	2,290.00	-49 .....	213.00	-84 .....	601.00																																																									
-2 (3")	1,707.00	-50 .....	213.00	-92 .....	2,735.00																																																									
-2 (4")	1,884.00	-60* (3")	953.00	-TSI .....	POA																																																									
-7 .....	872.00	-60* (4")	1,038.00	-VP .....	208.00																																																									
LIST PRICE																																																														
PIPE SIZE	<b>38930</b>																																																													
3", 4"	\$5,094.00																																																													
-7 .....	\$879.00	-C .....	\$560.00																																																											
-15 .....	348.00	-VP .....	212.00																																																											
-84 .....	601.00	-X .....	0.00																																																											
-92 .....	2,291.00																																																													
 <p><b>38640</b></p>	<p><b>13" x 11" TOP w/BUCKET</b></p> <table border="1"> <thead> <tr> <th colspan="2">LIST PRICE</th> </tr> </thead> <tbody> <tr> <td>PIPE SIZE</td> <td><b>38640</b></td> </tr> <tr> <td>2" - 4"</td> <td>\$3,194.00</td> </tr> </tbody> </table> <p><b>ADD FOR OPTIONS:</b></p> <table> <tr> <td>-1 .....</td> <td>\$1,923.00</td> <td>-84 .....</td> <td>\$601.00</td> </tr> <tr> <td>-2 .....</td> <td>1,595.00</td> <td>-92 .....</td> <td>1,430.00</td> </tr> <tr> <td>-7 .....</td> <td>879.00</td> <td>-VP .....</td> <td>212.00</td> </tr> <tr> <td>-70 .....</td> <td>Ded. 227.00</td> <td></td> <td></td> </tr> </table>	LIST PRICE		PIPE SIZE	<b>38640</b>	2" - 4"	\$3,194.00	-1 .....	\$1,923.00	-84 .....	\$601.00	-2 .....	1,595.00	-92 .....	1,430.00	-7 .....	879.00	-VP .....	212.00	-70 .....	Ded. 227.00			<p><b>Option Descriptions</b></p> <ul style="list-style-type: none"> <li>-AE LEVELEZE® Adjustable Extension</li> <li>-ARE Acid Resisting Epoxy</li> <li>-C Bolted Flashing Clamp Device</li> <li>-IGS Internal Gas Seal</li> <li>-LF Less Double Drainage Flange</li> <li>-LG Less Grate, Cast Iron</li> <li>-LG-1 Less Grate, Nikaloy</li> <li>-LG-2 Less Grate, Bronze</li> <li>-TSI Trap Seal Insert</li> <li>-VP Secured Grate, Vandal-Proof Screws</li> <li>-1 Satin Finish Nikaloy Top</li> <li>-2 Satin Finish Bronze Top</li> <li>-4 Secondary Flashing Clamp (use with -AE only)</li> <li>-7 Ductile Iron Grate</li> <li>-11 Extra-Heavy Grate, Cast Iron</li> <li>-14 Hinged Grate</li> <li>-15 Chained Grate</li> <li>-18 Hinged Grate with Latching Device</li> <li>-19 C.I. Undergrate with Satin Finish Nikaloy Top</li> <li>-20 C.I. Undergrate with Satin Finish Bronze Top</li> <li>-21 Loose-Set Grate</li> <li>-22 Less Latching Device</li> <li>-33 Galvanized Bucket Only</li> <li>-39 Solid Cast Iron Cover</li> <li>-49 3/4" Primer Tap</li> <li>-50 1/2" Primer Tap</li> <li>-51 1-1/2" Auxiliary Threaded Inlet</li> <li>-52 2" Auxiliary Threaded Inlet</li> <li>-60 Backwater Valve</li> <li>-61 Less Backwater Valve</li> <li>-69 Lift Handle for Sediment Bucket</li> <li>-70 Less Bucket</li> <li>-74 Aluminum Bucket</li> <li>-81 Slotted Cast Iron Bucket</li> <li>-81-92 Slotted Cast Iron Bucket, Galvanized</li> <li>-84 Stainless Steel Mesh Bucket Liner</li> <li>-88 Supplementary Strainer</li> <li>-92 Galvanized Cast Iron Parts</li> <li>-92-LF Galv. C.I. Parts, Less Double Drainage Flange</li> <li>-92-LG-LF Galv. C.I. Parts, Less Grate and Flange</li> </ul>																																						
LIST PRICE																																																														
PIPE SIZE	<b>38640</b>																																																													
2" - 4"	\$3,194.00																																																													
-1 .....	\$1,923.00	-84 .....	\$601.00																																																											
-2 .....	1,595.00	-92 .....	1,430.00																																																											
-7 .....	879.00	-VP .....	212.00																																																											
-70 .....	Ded. 227.00																																																													
 <p><b>38820</b></p>	<p><b>15" x 13" TOP, TRACTOR GRATE</b></p> <table border="1"> <thead> <tr> <th colspan="2">LIST PRICE</th> </tr> </thead> <tbody> <tr> <td>PIPE SIZE</td> <td><b>38820</b></td> </tr> <tr> <td>3", 4"</td> <td>\$4,956.00</td> </tr> </tbody> </table> <p><b>ADD FOR OPTIONS:</b></p> <table> <tr> <td>-1 .....</td> <td>\$2,100.00</td> <td>-49 .....</td> <td>\$213.00</td> <td>-84 .....</td> <td>\$601.00</td> </tr> <tr> <td>-2 .....</td> <td>1,894.00</td> <td>-50 .....</td> <td>213.00</td> <td>-92 .....</td> <td>1,329.00</td> </tr> <tr> <td>-7 .....</td> <td>863.00</td> <td>-66 .....</td> <td>530.00</td> <td>-TSI .....</td> <td>POA</td> </tr> <tr> <td>-15 .....</td> <td>348.00</td> <td>-74 .....</td> <td>532.00</td> <td>-X .....</td> <td>0.00</td> </tr> <tr> <td></td> <td></td> <td></td> <td></td> <td>-Z .....</td> <td>0.00</td> </tr> </table>	LIST PRICE		PIPE SIZE	<b>38820</b>	3", 4"	\$4,956.00	-1 .....	\$2,100.00	-49 .....	\$213.00	-84 .....	\$601.00	-2 .....	1,894.00	-50 .....	213.00	-92 .....	1,329.00	-7 .....	863.00	-66 .....	530.00	-TSI .....	POA	-15 .....	348.00	-74 .....	532.00	-X .....	0.00					-Z .....	0.00																									
LIST PRICE																																																														
PIPE SIZE	<b>38820</b>																																																													
3", 4"	\$4,956.00																																																													
-1 .....	\$2,100.00	-49 .....	\$213.00	-84 .....	\$601.00																																																									
-2 .....	1,894.00	-50 .....	213.00	-92 .....	1,329.00																																																									
-7 .....	863.00	-66 .....	530.00	-TSI .....	POA																																																									
-15 .....	348.00	-74 .....	532.00	-X .....	0.00																																																									
				-Z .....	0.00																																																									
 <p><b>38830</b></p>	<p><b>13-3/4" x 14-1/8" TOP w/HINGED GRATE</b></p> <table border="1"> <thead> <tr> <th colspan="2">LIST PRICE</th> </tr> </thead> <tbody> <tr> <td>PIPE SIZE</td> <td><b>38830</b></td> </tr> <tr> <td>3", 4"</td> <td>\$5,298.00</td> </tr> </tbody> </table> <p><b>ADD FOR OPTIONS:</b></p> <table> <tr> <td>-1 .....</td> <td>\$1,574.00</td> <td>-50 .....</td> <td>\$213.00</td> </tr> <tr> <td>-2 .....</td> <td>1,175.00</td> <td>-84 .....</td> <td>601.00</td> </tr> <tr> <td>-7 .....</td> <td>879.00</td> <td>-92 .....</td> <td>2,091.00</td> </tr> <tr> <td>-49 .....</td> <td>213.00</td> <td>-VP .....</td> <td>208.00</td> </tr> </table>	LIST PRICE		PIPE SIZE	<b>38830</b>	3", 4"	\$5,298.00	-1 .....	\$1,574.00	-50 .....	\$213.00	-2 .....	1,175.00	-84 .....	601.00	-7 .....	879.00	-92 .....	2,091.00	-49 .....	213.00	-VP .....	208.00	<p><b>Outlets</b></p> <ul style="list-style-type: none"> <li>-66 No-Hub Side Outlet</li> <li>-T Threaded Outlet</li> <li>-X Inside Caulk Outlet</li> <li>-Y Hub Outlet with Gasket, 2" - 4"</li> <li>-Z No-Hub Outlet</li> </ul>																																						
LIST PRICE																																																														
PIPE SIZE	<b>38830</b>																																																													
3", 4"	\$5,298.00																																																													
-1 .....	\$1,574.00	-50 .....	\$213.00																																																											
-2 .....	1,175.00	-84 .....	601.00																																																											
-7 .....	879.00	-92 .....	2,091.00																																																											
-49 .....	213.00	-VP .....	208.00																																																											







 <p><b>39240</b></p>	<p><b>SQUARE CAN WASH DRAIN</b></p> <table border="1"> <thead> <tr> <th colspan="2">LIST PRICE</th> </tr> </thead> <tbody> <tr> <td>PIPE SIZE</td> <td>39240</td> </tr> <tr> <td>3" - 4"</td> <td>\$4,043.00</td> </tr> </tbody> </table> <p><b>ADD FOR OPTIONS:</b></p> <table> <tr> <td>-1 .....\$1,138.00</td> <td>-C .....\$0.00</td> <td>-92 .....\$1,481.00</td> </tr> <tr> <td>-2 .....1,001.00</td> <td>-TSI .....POA</td> <td>-X .....0.00</td> </tr> <tr> <td>-15 .....348.00</td> <td>-66 .....530.00</td> <td>-Z .....0.00</td> </tr> <tr> <td></td> <td>-84 .....671.00</td> <td></td> </tr> </table>	LIST PRICE		PIPE SIZE	39240	3" - 4"	\$4,043.00	-1 .....\$1,138.00	-C .....\$0.00	-92 .....\$1,481.00	-2 .....1,001.00	-TSI .....POA	-X .....0.00	-15 .....348.00	-66 .....530.00	-Z .....0.00		-84 .....671.00		 <p><b>49300</b></p>	<p><b>SUPER-FLO® 8" SQUARE TOP, 6" DEEP</b></p> <table border="1"> <thead> <tr> <th colspan="5">LIST PRICE</th> </tr> <tr> <th>PIPE SIZE</th> <th>49300</th> <th>49300 -LF</th> <th>49300 -NB</th> <th>49300 -LF-NB</th> </tr> </thead> <tbody> <tr> <td>2" - 4"</td> <td>\$2,521.00</td> <td>\$2,262.00</td> <td>\$3,133.00</td> <td>\$2,873.00</td> </tr> </tbody> </table> <p><b>ADD FOR OPTIONS:</b></p> <table> <tr> <td>-3 .....\$0.00</td> <td>-35* .....\$671.00</td> </tr> <tr> <td>-4 .....0.00</td> <td>-43 .....446.00</td> </tr> <tr> <td>-7 .....256.00</td> <td>-45 .....Deduct 86.00</td> </tr> <tr> <td>-8 .....270.00</td> <td>-55** .....270.00</td> </tr> <tr> <td>-16 (ARE) .....543.00</td> <td>-C .....212.00</td> </tr> <tr> <td>-16 (NB) .....608.00</td> <td>-HG .....505.00</td> </tr> <tr> <td>-17 (ARE) .....699.00</td> <td>-LF .....Deduct 260.00</td> </tr> <tr> <td>-17 (NB) .....899.00</td> <td>-LG (ARE) Deduct 270.00</td> </tr> <tr> <td>-18 (ARE) .....756.00</td> <td>-LG (NB).. Deduct 434.00</td> </tr> <tr> <td>-18 (NB) .....1,262.00</td> <td>-NB .....612.00</td> </tr> <tr> <td>-20 (NB) .....323.00</td> <td>-TSI .....POA</td> </tr> <tr> <td>-24 (NB) .....308.00</td> <td>-VP (NB) .....110.00</td> </tr> <tr> <td>-31 .....288.00</td> <td>-X .....0.00</td> </tr> <tr> <td>-33 .....612.00</td> <td>-Y† .....0.00</td> </tr> <tr> <td></td> <td>-Z .....0.00</td> </tr> </table> <p>* Specify -31 or -33 Bucket      ** 88450 Provided † -Y Outlet only available on 3" -LF and 4" -LF</p>	LIST PRICE					PIPE SIZE	49300	49300 -LF	49300 -NB	49300 -LF-NB	2" - 4"	\$2,521.00	\$2,262.00	\$3,133.00	\$2,873.00	-3 .....\$0.00	-35* .....\$671.00	-4 .....0.00	-43 .....446.00	-7 .....256.00	-45 .....Deduct 86.00	-8 .....270.00	-55** .....270.00	-16 (ARE) .....543.00	-C .....212.00	-16 (NB) .....608.00	-HG .....505.00	-17 (ARE) .....699.00	-LF .....Deduct 260.00	-17 (NB) .....899.00	-LG (ARE) Deduct 270.00	-18 (ARE) .....756.00	-LG (NB).. Deduct 434.00	-18 (NB) .....1,262.00	-NB .....612.00	-20 (NB) .....323.00	-TSI .....POA	-24 (NB) .....308.00	-VP (NB) .....110.00	-31 .....288.00	-X .....0.00	-33 .....612.00	-Y† .....0.00		-Z .....0.00																																															
LIST PRICE																																																																																																																	
PIPE SIZE	39240																																																																																																																
3" - 4"	\$4,043.00																																																																																																																
-1 .....\$1,138.00	-C .....\$0.00	-92 .....\$1,481.00																																																																																																															
-2 .....1,001.00	-TSI .....POA	-X .....0.00																																																																																																															
-15 .....348.00	-66 .....530.00	-Z .....0.00																																																																																																															
	-84 .....671.00																																																																																																																
LIST PRICE																																																																																																																	
PIPE SIZE	49300	49300 -LF	49300 -NB	49300 -LF-NB																																																																																																													
2" - 4"	\$2,521.00	\$2,262.00	\$3,133.00	\$2,873.00																																																																																																													
-3 .....\$0.00	-35* .....\$671.00																																																																																																																
-4 .....0.00	-43 .....446.00																																																																																																																
-7 .....256.00	-45 .....Deduct 86.00																																																																																																																
-8 .....270.00	-55** .....270.00																																																																																																																
-16 (ARE) .....543.00	-C .....212.00																																																																																																																
-16 (NB) .....608.00	-HG .....505.00																																																																																																																
-17 (ARE) .....699.00	-LF .....Deduct 260.00																																																																																																																
-17 (NB) .....899.00	-LG (ARE) Deduct 270.00																																																																																																																
-18 (ARE) .....756.00	-LG (NB).. Deduct 434.00																																																																																																																
-18 (NB) .....1,262.00	-NB .....612.00																																																																																																																
-20 (NB) .....323.00	-TSI .....POA																																																																																																																
-24 (NB) .....308.00	-VP (NB) .....110.00																																																																																																																
-31 .....288.00	-X .....0.00																																																																																																																
-33 .....612.00	-Y† .....0.00																																																																																																																
	-Z .....0.00																																																																																																																
 <p><b>39600</b></p>	<p><b>PLANTING AREA DRAIN</b></p> <table border="1"> <thead> <tr> <th colspan="2">LIST PRICE</th> </tr> </thead> <tbody> <tr> <td>PIPE SIZE</td> <td>39600</td> </tr> <tr> <td>2" - 6"</td> <td>\$1,565.00</td> </tr> </tbody> </table> <p><b>ADD FOR OPTIONS:</b></p> <table> <tr> <td>-66 .....\$530.00</td> <td>-T .....\$112.00</td> <td>-Z .....\$0.00</td> </tr> <tr> <td>-89 .....213.00</td> <td>-TSI† .....POA</td> <td></td> </tr> <tr> <td>-92 .....560.00</td> <td>-X .....0.00</td> <td></td> </tr> </table> <p>†Available up to 4" only</p>	LIST PRICE		PIPE SIZE	39600	2" - 6"	\$1,565.00	-66 .....\$530.00	-T .....\$112.00	-Z .....\$0.00	-89 .....213.00	-TSI† .....POA		-92 .....560.00	-X .....0.00																																																																																																		
LIST PRICE																																																																																																																	
PIPE SIZE	39600																																																																																																																
2" - 6"	\$1,565.00																																																																																																																
-66 .....\$530.00	-T .....\$112.00	-Z .....\$0.00																																																																																																															
-89 .....213.00	-TSI† .....POA																																																																																																																
-92 .....560.00	-X .....0.00																																																																																																																
 <p><b>39720</b></p>	<p><b>11" TOP COMPOSITION DECK FLANGE</b></p> <table border="1"> <thead> <tr> <th colspan="2">LIST PRICE</th> </tr> </thead> <tbody> <tr> <td>PIPE SIZE</td> <td>39720</td> </tr> <tr> <td>2" - 4"</td> <td>\$2,893.00</td> </tr> </tbody> </table> <p><b>ADD FOR OPTIONS:</b></p> <table> <tr> <td>-1 .....\$1,080.00</td> <td>-13-2 \$1,526.00</td> <td>-84 .....\$671.00</td> </tr> <tr> <td>-2 .....943.00</td> <td>-15 .....348.00</td> <td>-92 .....1,302.00</td> </tr> <tr> <td>-7 .....377.00</td> <td>-TSI .....POA</td> <td>-T .....112.00</td> </tr> <tr> <td>-13 .....197.00</td> <td>-VP .....212.00</td> <td>-X .....0.00</td> </tr> <tr> <td>-13-1 ..1,780.00</td> <td>-70 Ded. 444.00</td> <td></td> </tr> </table>	LIST PRICE		PIPE SIZE	39720	2" - 4"	\$2,893.00	-1 .....\$1,080.00	-13-2 \$1,526.00	-84 .....\$671.00	-2 .....943.00	-15 .....348.00	-92 .....1,302.00	-7 .....377.00	-TSI .....POA	-T .....112.00	-13 .....197.00	-VP .....212.00	-X .....0.00	-13-1 ..1,780.00	-70 Ded. 444.00		 <p><b>49320A</b></p>	<p><b>12" SQUARE TOP, 6" DEEP</b></p> <table border="1"> <thead> <tr> <th colspan="5">LIST PRICE</th> </tr> <tr> <th>PIPE SIZE</th> <th>49320A</th> <th>49320A -LF</th> <th>49320A -NB</th> <th>49320A -LF-NB</th> </tr> </thead> <tbody> <tr> <td>2", 3", 4", 6"</td> <td>\$3,584.00</td> <td>\$3,033.00</td> <td>\$4,664.00</td> <td>\$4,114.00</td> </tr> </tbody> </table> <p><b>ADD FOR OPTIONS:</b></p> <table> <tr> <td>-3 .....\$0.00</td> <td>-35* .....\$671.00</td> </tr> <tr> <td>-4 .....0.00</td> <td>-43 .....485.00</td> </tr> <tr> <td>-5 .....1,560.00</td> <td>-45 .....Deduct 86.00</td> </tr> <tr> <td>-7 .....256.00</td> <td>-55** .....270.00</td> </tr> <tr> <td>-8 .....270.00</td> <td>-C .....268.00</td> </tr> <tr> <td>-15 .....1,737.00</td> <td>-LF .....Deduct 552.00</td> </tr> <tr> <td>-16 (ARE) .....543.00</td> <td>-LG (ARE) Deduct 324.00</td> </tr> <tr> <td>-16 (NB) .....608.00</td> <td>-LG (NB).. Deduct 705.00</td> </tr> <tr> <td>-17 (ARE) .....699.00</td> <td>-NB .....1,080.00</td> </tr> <tr> <td>-17 (NB) .....899.00</td> <td>-HG .....505.00</td> </tr> <tr> <td>-18 (ARE) .....756.00</td> <td>-TSI† .....POA</td> </tr> <tr> <td>-18 (NB) .....1,262.00</td> <td>-VP (NB) .....110.00</td> </tr> <tr> <td>-20 (NB) .....323.00</td> <td>-X .....0.00</td> </tr> <tr> <td>-24 (NB) .....308.00</td> <td>-Y (2" - 4") .....0.00</td> </tr> <tr> <td>-31 .....446.00</td> <td>-Z .....0.00</td> </tr> <tr> <td>-33 .....860.00</td> <td></td> </tr> </table> <p>*Specify -31 or -33 Bucket      †Available up to 4" only **88450 Provided for 2" - 4". Body Primer Tapped for 6".</p>	LIST PRICE					PIPE SIZE	49320A	49320A -LF	49320A -NB	49320A -LF-NB	2", 3", 4", 6"	\$3,584.00	\$3,033.00	\$4,664.00	\$4,114.00	-3 .....\$0.00	-35* .....\$671.00	-4 .....0.00	-43 .....485.00	-5 .....1,560.00	-45 .....Deduct 86.00	-7 .....256.00	-55** .....270.00	-8 .....270.00	-C .....268.00	-15 .....1,737.00	-LF .....Deduct 552.00	-16 (ARE) .....543.00	-LG (ARE) Deduct 324.00	-16 (NB) .....608.00	-LG (NB).. Deduct 705.00	-17 (ARE) .....699.00	-NB .....1,080.00	-17 (NB) .....899.00	-HG .....505.00	-18 (ARE) .....756.00	-TSI† .....POA	-18 (NB) .....1,262.00	-VP (NB) .....110.00	-20 (NB) .....323.00	-X .....0.00	-24 (NB) .....308.00	-Y (2" - 4") .....0.00	-31 .....446.00	-Z .....0.00	-33 .....860.00																																											
LIST PRICE																																																																																																																	
PIPE SIZE	39720																																																																																																																
2" - 4"	\$2,893.00																																																																																																																
-1 .....\$1,080.00	-13-2 \$1,526.00	-84 .....\$671.00																																																																																																															
-2 .....943.00	-15 .....348.00	-92 .....1,302.00																																																																																																															
-7 .....377.00	-TSI .....POA	-T .....112.00																																																																																																															
-13 .....197.00	-VP .....212.00	-X .....0.00																																																																																																															
-13-1 ..1,780.00	-70 Ded. 444.00																																																																																																																
LIST PRICE																																																																																																																	
PIPE SIZE	49320A	49320A -LF	49320A -NB	49320A -LF-NB																																																																																																													
2", 3", 4", 6"	\$3,584.00	\$3,033.00	\$4,664.00	\$4,114.00																																																																																																													
-3 .....\$0.00	-35* .....\$671.00																																																																																																																
-4 .....0.00	-43 .....485.00																																																																																																																
-5 .....1,560.00	-45 .....Deduct 86.00																																																																																																																
-7 .....256.00	-55** .....270.00																																																																																																																
-8 .....270.00	-C .....268.00																																																																																																																
-15 .....1,737.00	-LF .....Deduct 552.00																																																																																																																
-16 (ARE) .....543.00	-LG (ARE) Deduct 324.00																																																																																																																
-16 (NB) .....608.00	-LG (NB).. Deduct 705.00																																																																																																																
-17 (ARE) .....699.00	-NB .....1,080.00																																																																																																																
-17 (NB) .....899.00	-HG .....505.00																																																																																																																
-18 (ARE) .....756.00	-TSI† .....POA																																																																																																																
-18 (NB) .....1,262.00	-VP (NB) .....110.00																																																																																																																
-20 (NB) .....323.00	-X .....0.00																																																																																																																
-24 (NB) .....308.00	-Y (2" - 4") .....0.00																																																																																																																
-31 .....446.00	-Z .....0.00																																																																																																																
-33 .....860.00																																																																																																																	
 <p><b>39960</b></p>	<p><b>SQUARE TOP w/HINGED GRATE</b></p> <table border="1"> <thead> <tr> <th colspan="2">LIST PRICE</th> </tr> </thead> <tbody> <tr> <td>PIPE SIZE</td> <td>39960</td> </tr> <tr> <td>2"</td> <td>\$545.00</td> </tr> <tr> <td>3"</td> <td>666.00</td> </tr> </tbody> </table> <p><b>ADD FOR OPTIONS:</b></p> <table> <tr> <td>-VP .....\$212.00</td> <td>-92 .....\$466.00</td> </tr> <tr> <td>-ARE .....574.00</td> <td>-X .....0.00</td> </tr> <tr> <td>-TSI .....POA</td> <td></td> </tr> </table>	LIST PRICE		PIPE SIZE	39960	2"	\$545.00	3"	666.00	-VP .....\$212.00	-92 .....\$466.00	-ARE .....574.00	-X .....0.00	-TSI .....POA																																																																																																			
LIST PRICE																																																																																																																	
PIPE SIZE	39960																																																																																																																
2"	\$545.00																																																																																																																
3"	666.00																																																																																																																
-VP .....\$212.00	-92 .....\$466.00																																																																																																																
-ARE .....574.00	-X .....0.00																																																																																																																
-TSI .....POA																																																																																																																	
<p><b>Floor Drain Option Descriptions</b></p> <table> <tr> <td>-ARE</td> <td>Acid Resisting Epoxy</td> </tr> <tr> <td>-C</td> <td>Bolted Flashing Clamp Device</td> </tr> <tr> <td>-TSI</td> <td>Trap Seal Insert</td> </tr> <tr> <td>-VP</td> <td>Secured Grate, Vandal-Proof Screws</td> </tr> <tr> <td>-1</td> <td>Satin Finish Nikaloy Top</td> </tr> <tr> <td>-2</td> <td>Satin Finish Bronze Top</td> </tr> <tr> <td>-7</td> <td>Ductile Iron Grate</td> </tr> <tr> <td>-13</td> <td>Dome Grate, Cast Iron</td> </tr> <tr> <td>-13-1</td> <td>Dome Grate, Nikaloy</td> </tr> <tr> <td>-13-2</td> <td>Dome Grate, Bronze</td> </tr> <tr> <td>-15</td> <td>Chained Grate</td> </tr> <tr> <td>-70</td> <td>Less Bucket</td> </tr> <tr> <td>-84</td> <td>Stainless Steel Mesh Bucket Liner</td> </tr> <tr> <td>-89</td> <td>Deck Clamp Assembly</td> </tr> <tr> <td>-92</td> <td>Galvanized Cast Iron Parts</td> </tr> </table> <p>Outlets</p> <table> <tr> <td>-66</td> <td>No-Hub Side Outlet</td> </tr> <tr> <td>-T</td> <td>Threaded Outlet</td> </tr> <tr> <td>-X</td> <td>Inside Caulk Outlet</td> </tr> <tr> <td>-Z</td> <td>No-Hub Outlet</td> </tr> </table>		-ARE	Acid Resisting Epoxy	-C	Bolted Flashing Clamp Device	-TSI	Trap Seal Insert	-VP	Secured Grate, Vandal-Proof Screws	-1	Satin Finish Nikaloy Top	-2	Satin Finish Bronze Top	-7	Ductile Iron Grate	-13	Dome Grate, Cast Iron	-13-1	Dome Grate, Nikaloy	-13-2	Dome Grate, Bronze	-15	Chained Grate	-70	Less Bucket	-84	Stainless Steel Mesh Bucket Liner	-89	Deck Clamp Assembly	-92	Galvanized Cast Iron Parts	-66	No-Hub Side Outlet	-T	Threaded Outlet	-X	Inside Caulk Outlet	-Z	No-Hub Outlet	<p><b>Sanitary Floor Sink Option Descriptions</b></p> <table> <tr> <td>-C</td> <td>Clamp Device</td> <td>-31</td> <td>Sediment Bucket (Aluminum)</td> </tr> <tr> <td>-LF</td> <td>Less Flange</td> <td>-32</td> <td>Shallow Sediment Bucket (Aluminum)</td> </tr> <tr> <td>-LG</td> <td>Less Grate</td> <td>-33</td> <td>Sediment Bucket (A.R. Finish)</td> </tr> <tr> <td>-HG</td> <td>Hinged Grate (-NB Only)</td> <td>-35</td> <td>Stainless Steel Mesh Bucket Liner</td> </tr> <tr> <td>-NB</td> <td>Nickel Bronze Traffic Top</td> <td>-43</td> <td>Internal Dome Strainer (A.R. Finish)</td> </tr> <tr> <td>-TSI</td> <td>Trap Seal Insert</td> <td>-45</td> <td>Less Internal Dome Strainer</td> </tr> <tr> <td>-VP</td> <td>Secured Grate, Vandal-Proof Screws</td> <td>-51</td> <td>Galvanized Cast Iron Inside and Outside</td> </tr> <tr> <td>-3</td> <td>1/2 Grate</td> <td>-52</td> <td>Painted Inside and Outside</td> </tr> <tr> <td>-4</td> <td>3/4 Grate</td> <td>-55</td> <td>1/2" Primer Tap or Adapter</td> </tr> <tr> <td>-5</td> <td>Nikaloy Extra Heavy-Duty Grate &amp; Rim (Not SUPER-FLO® Design)</td> <td></td> <td></td> </tr> <tr> <td>-7</td> <td>Full Grate w/ 2-1/2" Center Opening</td> <td></td> <td></td> </tr> <tr> <td>-8</td> <td>Stainless Steel Depressed Grate</td> <td></td> <td></td> </tr> <tr> <td>-15</td> <td>Stainless Steel Rim and Grate</td> <td></td> <td></td> </tr> <tr> <td>-16</td> <td>Grate with 4" Round Funnel</td> <td>Outlets</td> <td></td> </tr> <tr> <td>-17</td> <td>Grate with 6" Round Funnel</td> <td>-X</td> <td>Inside Caulk Outlet</td> </tr> <tr> <td>-18</td> <td>Grate with 9" x 3-1/2" Oval Funnel</td> <td>-Y</td> <td>Hub Outlet w/Gasket 2" - 4"</td> </tr> <tr> <td>-20</td> <td>Solid Nikaloy Cover</td> <td>-Z</td> <td>No-Hub Outlet</td> </tr> <tr> <td>-24</td> <td>Chained Grate</td> <td></td> <td></td> </tr> </table>		-C	Clamp Device	-31	Sediment Bucket (Aluminum)	-LF	Less Flange	-32	Shallow Sediment Bucket (Aluminum)	-LG	Less Grate	-33	Sediment Bucket (A.R. Finish)	-HG	Hinged Grate (-NB Only)	-35	Stainless Steel Mesh Bucket Liner	-NB	Nickel Bronze Traffic Top	-43	Internal Dome Strainer (A.R. Finish)	-TSI	Trap Seal Insert	-45	Less Internal Dome Strainer	-VP	Secured Grate, Vandal-Proof Screws	-51	Galvanized Cast Iron Inside and Outside	-3	1/2 Grate	-52	Painted Inside and Outside	-4	3/4 Grate	-55	1/2" Primer Tap or Adapter	-5	Nikaloy Extra Heavy-Duty Grate & Rim (Not SUPER-FLO® Design)			-7	Full Grate w/ 2-1/2" Center Opening			-8	Stainless Steel Depressed Grate			-15	Stainless Steel Rim and Grate			-16	Grate with 4" Round Funnel	Outlets		-17	Grate with 6" Round Funnel	-X	Inside Caulk Outlet	-18	Grate with 9" x 3-1/2" Oval Funnel	-Y	Hub Outlet w/Gasket 2" - 4"	-20	Solid Nikaloy Cover	-Z	No-Hub Outlet	-24	Chained Grate		
-ARE	Acid Resisting Epoxy																																																																																																																
-C	Bolted Flashing Clamp Device																																																																																																																
-TSI	Trap Seal Insert																																																																																																																
-VP	Secured Grate, Vandal-Proof Screws																																																																																																																
-1	Satin Finish Nikaloy Top																																																																																																																
-2	Satin Finish Bronze Top																																																																																																																
-7	Ductile Iron Grate																																																																																																																
-13	Dome Grate, Cast Iron																																																																																																																
-13-1	Dome Grate, Nikaloy																																																																																																																
-13-2	Dome Grate, Bronze																																																																																																																
-15	Chained Grate																																																																																																																
-70	Less Bucket																																																																																																																
-84	Stainless Steel Mesh Bucket Liner																																																																																																																
-89	Deck Clamp Assembly																																																																																																																
-92	Galvanized Cast Iron Parts																																																																																																																
-66	No-Hub Side Outlet																																																																																																																
-T	Threaded Outlet																																																																																																																
-X	Inside Caulk Outlet																																																																																																																
-Z	No-Hub Outlet																																																																																																																
-C	Clamp Device	-31	Sediment Bucket (Aluminum)																																																																																																														
-LF	Less Flange	-32	Shallow Sediment Bucket (Aluminum)																																																																																																														
-LG	Less Grate	-33	Sediment Bucket (A.R. Finish)																																																																																																														
-HG	Hinged Grate (-NB Only)	-35	Stainless Steel Mesh Bucket Liner																																																																																																														
-NB	Nickel Bronze Traffic Top	-43	Internal Dome Strainer (A.R. Finish)																																																																																																														
-TSI	Trap Seal Insert	-45	Less Internal Dome Strainer																																																																																																														
-VP	Secured Grate, Vandal-Proof Screws	-51	Galvanized Cast Iron Inside and Outside																																																																																																														
-3	1/2 Grate	-52	Painted Inside and Outside																																																																																																														
-4	3/4 Grate	-55	1/2" Primer Tap or Adapter																																																																																																														
-5	Nikaloy Extra Heavy-Duty Grate & Rim (Not SUPER-FLO® Design)																																																																																																																
-7	Full Grate w/ 2-1/2" Center Opening																																																																																																																
-8	Stainless Steel Depressed Grate																																																																																																																
-15	Stainless Steel Rim and Grate																																																																																																																
-16	Grate with 4" Round Funnel	Outlets																																																																																																															
-17	Grate with 6" Round Funnel	-X	Inside Caulk Outlet																																																																																																														
-18	Grate with 9" x 3-1/2" Oval Funnel	-Y	Hub Outlet w/Gasket 2" - 4"																																																																																																														
-20	Solid Nikaloy Cover	-Z	No-Hub Outlet																																																																																																														
-24	Chained Grate																																																																																																																







# SANITARY FLOOR SINKS



A WATTS Brand

 <p><b>49340A</b></p>	<p align="center"><b>12" SQUARE TOP, 8" DEEP</b></p> <table border="1"> <thead> <tr> <th colspan="5">LIST PRICE</th> </tr> <tr> <th>PIPE SIZE</th> <th>49340A</th> <th>49340A -LF</th> <th>49340A -NB</th> <th>49340A -LF-NB</th> </tr> </thead> <tbody> <tr> <td>2" - 4"</td> <td>\$3,736.00</td> <td>\$3,185.00</td> <td>\$4,816.00</td> <td>\$4,264.00</td> </tr> </tbody> </table> <p><b>ADD FOR OPTIONS:</b></p> <table> <tbody> <tr><td>-3</td><td>\$0.00</td><td>-35*</td><td>\$671.00</td></tr> <tr><td>-4</td><td>0.00</td><td>-43</td><td>485.00</td></tr> <tr><td>-5</td><td>1,560.00</td><td>-45</td><td>Deduct 86.00</td></tr> <tr><td>-7</td><td>256.00</td><td>-55**</td><td>270.00</td></tr> <tr><td>-8</td><td>270.00</td><td>-C</td><td>268.00</td></tr> <tr><td>-15</td><td>1,737.00</td><td>-HG</td><td>505.00</td></tr> <tr><td>-16 (ARE)</td><td>543.00</td><td>-LF</td><td>Deduct 552.00</td></tr> <tr><td>-16 (NB)</td><td>608.00</td><td>-LG (ARE)</td><td>Deduct 324.00</td></tr> <tr><td>-17 (ARE)</td><td>699.00</td><td>-LG (NB)</td><td>Deduct 705.00</td></tr> <tr><td>-17 (NB)</td><td>899.00</td><td>-NB</td><td>1,080.00</td></tr> <tr><td>-18 (ARE)</td><td>756.00</td><td>-TSI</td><td>POA</td></tr> <tr><td>-18 (NB)</td><td>1,262.00</td><td>-VP (NB)</td><td>110.00</td></tr> <tr><td>-20 (NB)</td><td>323.00</td><td>-X</td><td>0.00</td></tr> <tr><td>-24 (NB)</td><td>308.00</td><td>-Y</td><td>0.00</td></tr> <tr><td>-31</td><td>446.00</td><td>-Z</td><td>0.00</td></tr> <tr><td>-33</td><td>860.00</td><td></td><td></td></tr> </tbody> </table> <p>* Specify -31 or -33 Bucket      **88450 Provided</p>	LIST PRICE					PIPE SIZE	49340A	49340A -LF	49340A -NB	49340A -LF-NB	2" - 4"	\$3,736.00	\$3,185.00	\$4,816.00	\$4,264.00	-3	\$0.00	-35*	\$671.00	-4	0.00	-43	485.00	-5	1,560.00	-45	Deduct 86.00	-7	256.00	-55**	270.00	-8	270.00	-C	268.00	-15	1,737.00	-HG	505.00	-16 (ARE)	543.00	-LF	Deduct 552.00	-16 (NB)	608.00	-LG (ARE)	Deduct 324.00	-17 (ARE)	699.00	-LG (NB)	Deduct 705.00	-17 (NB)	899.00	-NB	1,080.00	-18 (ARE)	756.00	-TSI	POA	-18 (NB)	1,262.00	-VP (NB)	110.00	-20 (NB)	323.00	-X	0.00	-24 (NB)	308.00	-Y	0.00	-31	446.00	-Z	0.00	-33	860.00			 <p><b>49420</b></p>	<p align="center"><b>SUPER-FLO® 16" SQUARE TOP, 12" DEEP</b></p> <table border="1"> <thead> <tr> <th colspan="5">LIST PRICE</th> </tr> <tr> <th>PIPE SIZE</th> <th>49420</th> <th>49420 -LF</th> <th>49420 -NB</th> <th>49420 -LF-NB</th> </tr> </thead> <tbody> <tr> <td>3", 4", 6"</td> <td>\$6,732.00</td> <td>\$6,015.00</td> <td>\$8,480.00</td> <td>\$7,762.00</td> </tr> </tbody> </table> <p><b>ADD FOR OPTIONS:</b></p> <table> <tbody> <tr><td>-3</td><td>\$0.00</td><td>-43</td><td>\$446.00</td></tr> <tr><td>-4</td><td>0.00</td><td>-45</td><td>Deduct 86.00</td></tr> <tr><td>-7</td><td>256.00</td><td>-55**</td><td>270.00</td></tr> <tr><td>-16 (ARE)</td><td>543.00</td><td>-C</td><td>805.00</td></tr> <tr><td>-16 (NB)</td><td>608.00</td><td>-LF</td><td>Deduct 718.00</td></tr> <tr><td>-17 (ARE)</td><td>699.00</td><td>-LG (ARE)</td><td>Deduct 538.00</td></tr> <tr><td>-17 (NB)</td><td>899.00</td><td>-LG (NB)</td><td>Deduct 1,490.00</td></tr> <tr><td>-18 (ARE)</td><td>756.00</td><td>-NB</td><td>1,746.00</td></tr> <tr><td>-18 (NB)</td><td>1,259.00</td><td>-TSI†</td><td>POA</td></tr> <tr><td>-31</td><td>1,191.00</td><td>-VP (NB)</td><td>110.00</td></tr> <tr><td>-33</td><td>3,351.00</td><td>-X</td><td>0.00</td></tr> <tr><td>-35*</td><td>1,347.00</td><td></td><td></td></tr> </tbody> </table> <p>* Specify -31 or -33 Bucket ** 88450 Provided for 3" &amp; 4" Body Primer Tapped for 6" † Available up to 4" only</p>	LIST PRICE					PIPE SIZE	49420	49420 -LF	49420 -NB	49420 -LF-NB	3", 4", 6"	\$6,732.00	\$6,015.00	\$8,480.00	\$7,762.00	-3	\$0.00	-43	\$446.00	-4	0.00	-45	Deduct 86.00	-7	256.00	-55**	270.00	-16 (ARE)	543.00	-C	805.00	-16 (NB)	608.00	-LF	Deduct 718.00	-17 (ARE)	699.00	-LG (ARE)	Deduct 538.00	-17 (NB)	899.00	-LG (NB)	Deduct 1,490.00	-18 (ARE)	756.00	-NB	1,746.00	-18 (NB)	1,259.00	-TSI†	POA	-31	1,191.00	-VP (NB)	110.00	-33	3,351.00	-X	0.00	-35*	1,347.00						
LIST PRICE																																																																																																																																																					
PIPE SIZE	49340A	49340A -LF	49340A -NB	49340A -LF-NB																																																																																																																																																	
2" - 4"	\$3,736.00	\$3,185.00	\$4,816.00	\$4,264.00																																																																																																																																																	
-3	\$0.00	-35*	\$671.00																																																																																																																																																		
-4	0.00	-43	485.00																																																																																																																																																		
-5	1,560.00	-45	Deduct 86.00																																																																																																																																																		
-7	256.00	-55**	270.00																																																																																																																																																		
-8	270.00	-C	268.00																																																																																																																																																		
-15	1,737.00	-HG	505.00																																																																																																																																																		
-16 (ARE)	543.00	-LF	Deduct 552.00																																																																																																																																																		
-16 (NB)	608.00	-LG (ARE)	Deduct 324.00																																																																																																																																																		
-17 (ARE)	699.00	-LG (NB)	Deduct 705.00																																																																																																																																																		
-17 (NB)	899.00	-NB	1,080.00																																																																																																																																																		
-18 (ARE)	756.00	-TSI	POA																																																																																																																																																		
-18 (NB)	1,262.00	-VP (NB)	110.00																																																																																																																																																		
-20 (NB)	323.00	-X	0.00																																																																																																																																																		
-24 (NB)	308.00	-Y	0.00																																																																																																																																																		
-31	446.00	-Z	0.00																																																																																																																																																		
-33	860.00																																																																																																																																																				
LIST PRICE																																																																																																																																																					
PIPE SIZE	49420	49420 -LF	49420 -NB	49420 -LF-NB																																																																																																																																																	
3", 4", 6"	\$6,732.00	\$6,015.00	\$8,480.00	\$7,762.00																																																																																																																																																	
-3	\$0.00	-43	\$446.00																																																																																																																																																		
-4	0.00	-45	Deduct 86.00																																																																																																																																																		
-7	256.00	-55**	270.00																																																																																																																																																		
-16 (ARE)	543.00	-C	805.00																																																																																																																																																		
-16 (NB)	608.00	-LF	Deduct 718.00																																																																																																																																																		
-17 (ARE)	699.00	-LG (ARE)	Deduct 538.00																																																																																																																																																		
-17 (NB)	899.00	-LG (NB)	Deduct 1,490.00																																																																																																																																																		
-18 (ARE)	756.00	-NB	1,746.00																																																																																																																																																		
-18 (NB)	1,259.00	-TSI†	POA																																																																																																																																																		
-31	1,191.00	-VP (NB)	110.00																																																																																																																																																		
-33	3,351.00	-X	0.00																																																																																																																																																		
-35*	1,347.00																																																																																																																																																				
 <p><b>49360A</b></p>	<p align="center"><b>12" SQUARE TOP, 10" DEEP</b></p> <table border="1"> <thead> <tr> <th colspan="5">LIST PRICE</th> </tr> <tr> <th>PIPE SIZE</th> <th>49360A</th> <th>49360A -LF</th> <th>49360A -NB</th> <th>49360A -LF-NB</th> </tr> </thead> <tbody> <tr> <td>2" - 4"</td> <td>\$3,919.00</td> <td>\$3,367.00</td> <td>\$5,000.00</td> <td>\$4,448.00</td> </tr> </tbody> </table> <p><b>ADD FOR OPTIONS:</b></p> <table> <tbody> <tr><td>-3</td><td>\$0.00</td><td>-33</td><td>\$860.00</td></tr> <tr><td>-4</td><td>0.00</td><td>-35*</td><td>671.00</td></tr> <tr><td>-5</td><td>1,560.00</td><td>-43</td><td>485.00</td></tr> <tr><td>-7</td><td>256.00</td><td>-45</td><td>Deduct 86.00</td></tr> <tr><td>-8</td><td>270.00</td><td>-55**</td><td>270.00</td></tr> <tr><td>-15</td><td>1,737.00</td><td>-C</td><td>268.00</td></tr> <tr><td>-16 (ARE)</td><td>543.00</td><td>-HG</td><td>505.00</td></tr> <tr><td>-16 (NB)</td><td>608.00</td><td>-LF</td><td>Deduct 552.00</td></tr> <tr><td>-17 (ARE)</td><td>699.00</td><td>-LG (ARE)</td><td>Deduct 324.00</td></tr> <tr><td>-17 (NB)</td><td>899.00</td><td>-LG (NB)</td><td>Deduct 705.00</td></tr> <tr><td>-18 (ARE)</td><td>756.00</td><td>-NB</td><td>1,080.00</td></tr> <tr><td>-18 (NB)</td><td>1,262.00</td><td>-TSI</td><td>POA</td></tr> <tr><td>-20 (NB)</td><td>323.00</td><td>-VP (NB)</td><td>110.00</td></tr> <tr><td>-24 (NB)</td><td>308.00</td><td>-X</td><td>0.00</td></tr> <tr><td>-31</td><td>446.00</td><td>-Y</td><td>0.00</td></tr> <tr><td>-32</td><td>446.00</td><td>-Z</td><td>0.00</td></tr> </tbody> </table> <p>* Specify -31 or -33 Bucket      **88450 Provided</p>	LIST PRICE					PIPE SIZE	49360A	49360A -LF	49360A -NB	49360A -LF-NB	2" - 4"	\$3,919.00	\$3,367.00	\$5,000.00	\$4,448.00	-3	\$0.00	-33	\$860.00	-4	0.00	-35*	671.00	-5	1,560.00	-43	485.00	-7	256.00	-45	Deduct 86.00	-8	270.00	-55**	270.00	-15	1,737.00	-C	268.00	-16 (ARE)	543.00	-HG	505.00	-16 (NB)	608.00	-LF	Deduct 552.00	-17 (ARE)	699.00	-LG (ARE)	Deduct 324.00	-17 (NB)	899.00	-LG (NB)	Deduct 705.00	-18 (ARE)	756.00	-NB	1,080.00	-18 (NB)	1,262.00	-TSI	POA	-20 (NB)	323.00	-VP (NB)	110.00	-24 (NB)	308.00	-X	0.00	-31	446.00	-Y	0.00	-32	446.00	-Z	0.00	 <p><b>49500</b></p>	<p align="center"><b>SUPER-FLO® 8" ROUND TOP, 3" DEEP</b></p> <table border="1"> <thead> <tr> <th colspan="5">LIST PRICE</th> </tr> <tr> <th>PIPE SIZE</th> <th>49500</th> <th>49500 -LF</th> <th>49500 -NB</th> <th>49500 -LF-NB</th> </tr> </thead> <tbody> <tr> <td>2" - 4"</td> <td>\$2,237.00</td> <td>\$1,827.00</td> <td>\$2,589.00</td> <td>\$2,180.00</td> </tr> </tbody> </table> <p><b>ADD FOR OPTIONS:</b></p> <table> <tbody> <tr><td>-3</td><td>\$0.00</td><td>-43</td><td>\$446.00</td></tr> <tr><td>-4</td><td>0.00</td><td>-45</td><td>Deduct 86.00</td></tr> <tr><td>-7</td><td>256.00</td><td>-51</td><td>0.00</td></tr> <tr><td>-8</td><td>268.00</td><td>-52</td><td>Deduct 256.00</td></tr> <tr><td>-16 (ARE)</td><td>543.00</td><td>-55**</td><td>270.00</td></tr> <tr><td>-16 (NB)</td><td>608.00</td><td>-C</td><td>268.00</td></tr> <tr><td>-17 (ARE)</td><td>699.00</td><td>-LF</td><td>Deduct 411.00</td></tr> <tr><td>-17 (NB)</td><td>899.00</td><td>-LG (ARE)</td><td>Deduct 270.00</td></tr> <tr><td>-18 (ARE)</td><td>756.00</td><td>-LG (NB)</td><td>Deduct 296.00</td></tr> <tr><td>-18 (NB)</td><td>1,259.00</td><td>-NB</td><td>351.00</td></tr> <tr><td>-31</td><td>323.00</td><td>-TSI</td><td>POA</td></tr> <tr><td>-33</td><td>776.00</td><td>-X</td><td>0.00</td></tr> <tr><td>-35*</td><td>671.00</td><td>-VP (NB)</td><td>110.00</td></tr> </tbody> </table> <p>* Specify -31 or -33 Bucket      **88450 Provided</p>	LIST PRICE					PIPE SIZE	49500	49500 -LF	49500 -NB	49500 -LF-NB	2" - 4"	\$2,237.00	\$1,827.00	\$2,589.00	\$2,180.00	-3	\$0.00	-43	\$446.00	-4	0.00	-45	Deduct 86.00	-7	256.00	-51	0.00	-8	268.00	-52	Deduct 256.00	-16 (ARE)	543.00	-55**	270.00	-16 (NB)	608.00	-C	268.00	-17 (ARE)	699.00	-LF	Deduct 411.00	-17 (NB)	899.00	-LG (ARE)	Deduct 270.00	-18 (ARE)	756.00	-LG (NB)	Deduct 296.00	-18 (NB)	1,259.00	-NB	351.00	-31	323.00	-TSI	POA	-33	776.00	-X	0.00	-35*	671.00	-VP (NB)	110.00
LIST PRICE																																																																																																																																																					
PIPE SIZE	49360A	49360A -LF	49360A -NB	49360A -LF-NB																																																																																																																																																	
2" - 4"	\$3,919.00	\$3,367.00	\$5,000.00	\$4,448.00																																																																																																																																																	
-3	\$0.00	-33	\$860.00																																																																																																																																																		
-4	0.00	-35*	671.00																																																																																																																																																		
-5	1,560.00	-43	485.00																																																																																																																																																		
-7	256.00	-45	Deduct 86.00																																																																																																																																																		
-8	270.00	-55**	270.00																																																																																																																																																		
-15	1,737.00	-C	268.00																																																																																																																																																		
-16 (ARE)	543.00	-HG	505.00																																																																																																																																																		
-16 (NB)	608.00	-LF	Deduct 552.00																																																																																																																																																		
-17 (ARE)	699.00	-LG (ARE)	Deduct 324.00																																																																																																																																																		
-17 (NB)	899.00	-LG (NB)	Deduct 705.00																																																																																																																																																		
-18 (ARE)	756.00	-NB	1,080.00																																																																																																																																																		
-18 (NB)	1,262.00	-TSI	POA																																																																																																																																																		
-20 (NB)	323.00	-VP (NB)	110.00																																																																																																																																																		
-24 (NB)	308.00	-X	0.00																																																																																																																																																		
-31	446.00	-Y	0.00																																																																																																																																																		
-32	446.00	-Z	0.00																																																																																																																																																		
LIST PRICE																																																																																																																																																					
PIPE SIZE	49500	49500 -LF	49500 -NB	49500 -LF-NB																																																																																																																																																	
2" - 4"	\$2,237.00	\$1,827.00	\$2,589.00	\$2,180.00																																																																																																																																																	
-3	\$0.00	-43	\$446.00																																																																																																																																																		
-4	0.00	-45	Deduct 86.00																																																																																																																																																		
-7	256.00	-51	0.00																																																																																																																																																		
-8	268.00	-52	Deduct 256.00																																																																																																																																																		
-16 (ARE)	543.00	-55**	270.00																																																																																																																																																		
-16 (NB)	608.00	-C	268.00																																																																																																																																																		
-17 (ARE)	699.00	-LF	Deduct 411.00																																																																																																																																																		
-17 (NB)	899.00	-LG (ARE)	Deduct 270.00																																																																																																																																																		
-18 (ARE)	756.00	-LG (NB)	Deduct 296.00																																																																																																																																																		
-18 (NB)	1,259.00	-NB	351.00																																																																																																																																																		
-31	323.00	-TSI	POA																																																																																																																																																		
-33	776.00	-X	0.00																																																																																																																																																		
-35*	671.00	-VP (NB)	110.00																																																																																																																																																		
 <p><b>49400</b></p>	<p align="center"><b>SUPER-FLO® 16" SQUARE TOP, 6" DEEP</b></p> <table border="1"> <thead> <tr> <th colspan="5">LIST PRICE</th> </tr> <tr> <th>PIPE SIZE</th> <th>49400</th> <th>49400 -LF</th> <th>49400 -NB</th> <th>49400 -LF-NB</th> </tr> </thead> <tbody> <tr> <td>2", 4", 6"</td> <td>\$6,732.00</td> <td>\$6,201.00</td> <td>\$8,480.00</td> <td>\$7,947.00</td> </tr> </tbody> </table> <p><b>ADD FOR OPTIONS:</b></p> <table> <tbody> <tr><td>-3</td><td>\$0.00</td><td>-43</td><td>\$447.00</td></tr> <tr><td>-4</td><td>0.00</td><td>-45</td><td>Deduct 86.00</td></tr> <tr><td>-7</td><td>256.00</td><td>-55**</td><td>270.00</td></tr> <tr><td>-16 (ARE)</td><td>543.00</td><td>-C</td><td>805.00</td></tr> <tr><td>-16 (NB)</td><td>608.00</td><td>-LF</td><td>Deduct 530.00</td></tr> <tr><td>-17 (ARE)</td><td>699.00</td><td>-LG (ARE)</td><td>Deduct 538.00</td></tr> <tr><td>-17 (NB)</td><td>899.00</td><td>-LG (NB)</td><td>Deduct 1,490.00</td></tr> <tr><td>-18 (ARE)</td><td>756.00</td><td>-NB</td><td>1,746.00</td></tr> <tr><td>-18 (NB)</td><td>1,259.00</td><td>-TSI†</td><td>POA</td></tr> <tr><td>-31</td><td>1,191.00</td><td>-VP (NB)</td><td>110.00</td></tr> <tr><td>-33</td><td>3,351.00</td><td>-X</td><td>0.00</td></tr> <tr><td>-35*</td><td>1,347.00</td><td></td><td></td></tr> </tbody> </table> <p>* Specify -31 or -33 Bucket ** 88450 Provided for 3" &amp; 4" Body Primer Tapped for 6" † Available up to 4" only</p>	LIST PRICE					PIPE SIZE	49400	49400 -LF	49400 -NB	49400 -LF-NB	2", 4", 6"	\$6,732.00	\$6,201.00	\$8,480.00	\$7,947.00	-3	\$0.00	-43	\$447.00	-4	0.00	-45	Deduct 86.00	-7	256.00	-55**	270.00	-16 (ARE)	543.00	-C	805.00	-16 (NB)	608.00	-LF	Deduct 530.00	-17 (ARE)	699.00	-LG (ARE)	Deduct 538.00	-17 (NB)	899.00	-LG (NB)	Deduct 1,490.00	-18 (ARE)	756.00	-NB	1,746.00	-18 (NB)	1,259.00	-TSI†	POA	-31	1,191.00	-VP (NB)	110.00	-33	3,351.00	-X	0.00	-35*	1,347.00			 <p><b>49520A</b></p>	<p align="center"><b>SUPER-FLO® 8" ROUND TOP, 6" DEEP</b></p> <table border="1"> <thead> <tr> <th colspan="5">LIST PRICE</th> </tr> <tr> <th>PIPE SIZE</th> <th>49520A</th> <th>49520A -LF</th> <th>49520A -NB</th> <th>49520A -LF-NB</th> </tr> </thead> <tbody> <tr> <td>2" - 4"</td> <td>\$2,305.00</td> <td>\$1,894.00</td> <td>\$2,956.00</td> <td>\$2,545.00</td> </tr> </tbody> </table> <p><b>ADD FOR OPTIONS:</b></p> <table> <tbody> <tr><td>-3</td><td>\$0.00</td><td>-45</td><td>Deduct \$86.00</td></tr> <tr><td>-4</td><td>0.00</td><td>-51</td><td>0.00</td></tr> <tr><td>-7</td><td>256.00</td><td>-52</td><td>Deduct 237.00</td></tr> <tr><td>-8</td><td>268.00</td><td>-55**</td><td>270.00</td></tr> <tr><td>-16 (ARE)</td><td>543.00</td><td>-C</td><td>268.00</td></tr> <tr><td>-16 (NB)</td><td>608.00</td><td>-LF</td><td>Deduct 411.00</td></tr> <tr><td>-17 (ARE)</td><td>699.00</td><td>-LG (ARE)</td><td>Deduct 270.00</td></tr> <tr><td>-17 (NB)</td><td>899.00</td><td>-LG (NB)</td><td>Deduct 296.00</td></tr> <tr><td>-18 (ARE)</td><td>756.00</td><td>-NB</td><td>652.00</td></tr> <tr><td>-18 (NB)</td><td>1,259.00</td><td>-TSI</td><td>POA</td></tr> <tr><td>-31</td><td>323.00</td><td>-VP (NB)</td><td>110.00</td></tr> <tr><td>-33</td><td>776.00</td><td>-X</td><td>0.00</td></tr> <tr><td>-35*</td><td>671.00</td><td>-Z</td><td>0.00</td></tr> <tr><td>-43</td><td>446.00</td><td></td><td></td></tr> </tbody> </table> <p>* Specify -31 or -33 Bucket      **88450 Provided</p>	LIST PRICE					PIPE SIZE	49520A	49520A -LF	49520A -NB	49520A -LF-NB	2" - 4"	\$2,305.00	\$1,894.00	\$2,956.00	\$2,545.00	-3	\$0.00	-45	Deduct \$86.00	-4	0.00	-51	0.00	-7	256.00	-52	Deduct 237.00	-8	268.00	-55**	270.00	-16 (ARE)	543.00	-C	268.00	-16 (NB)	608.00	-LF	Deduct 411.00	-17 (ARE)	699.00	-LG (ARE)	Deduct 270.00	-17 (NB)	899.00	-LG (NB)	Deduct 296.00	-18 (ARE)	756.00	-NB	652.00	-18 (NB)	1,259.00	-TSI	POA	-31	323.00	-VP (NB)	110.00	-33	776.00	-X	0.00	-35*	671.00	-Z	0.00	-43	446.00														
LIST PRICE																																																																																																																																																					
PIPE SIZE	49400	49400 -LF	49400 -NB	49400 -LF-NB																																																																																																																																																	
2", 4", 6"	\$6,732.00	\$6,201.00	\$8,480.00	\$7,947.00																																																																																																																																																	
-3	\$0.00	-43	\$447.00																																																																																																																																																		
-4	0.00	-45	Deduct 86.00																																																																																																																																																		
-7	256.00	-55**	270.00																																																																																																																																																		
-16 (ARE)	543.00	-C	805.00																																																																																																																																																		
-16 (NB)	608.00	-LF	Deduct 530.00																																																																																																																																																		
-17 (ARE)	699.00	-LG (ARE)	Deduct 538.00																																																																																																																																																		
-17 (NB)	899.00	-LG (NB)	Deduct 1,490.00																																																																																																																																																		
-18 (ARE)	756.00	-NB	1,746.00																																																																																																																																																		
-18 (NB)	1,259.00	-TSI†	POA																																																																																																																																																		
-31	1,191.00	-VP (NB)	110.00																																																																																																																																																		
-33	3,351.00	-X	0.00																																																																																																																																																		
-35*	1,347.00																																																																																																																																																				
LIST PRICE																																																																																																																																																					
PIPE SIZE	49520A	49520A -LF	49520A -NB	49520A -LF-NB																																																																																																																																																	
2" - 4"	\$2,305.00	\$1,894.00	\$2,956.00	\$2,545.00																																																																																																																																																	
-3	\$0.00	-45	Deduct \$86.00																																																																																																																																																		
-4	0.00	-51	0.00																																																																																																																																																		
-7	256.00	-52	Deduct 237.00																																																																																																																																																		
-8	268.00	-55**	270.00																																																																																																																																																		
-16 (ARE)	543.00	-C	268.00																																																																																																																																																		
-16 (NB)	608.00	-LF	Deduct 411.00																																																																																																																																																		
-17 (ARE)	699.00	-LG (ARE)	Deduct 270.00																																																																																																																																																		
-17 (NB)	899.00	-LG (NB)	Deduct 296.00																																																																																																																																																		
-18 (ARE)	756.00	-NB	652.00																																																																																																																																																		
-18 (NB)	1,259.00	-TSI	POA																																																																																																																																																		
-31	323.00	-VP (NB)	110.00																																																																																																																																																		
-33	776.00	-X	0.00																																																																																																																																																		
-35*	671.00	-Z	0.00																																																																																																																																																		
-43	446.00																																																																																																																																																				

 <p><b>49580A</b></p>	<p><b>SUPER-FLO® 12" ROUND TOP, 8" DEEP</b></p> <table border="1"> <thead> <tr> <th colspan="5">LIST PRICE</th> </tr> <tr> <th>PIPE SIZE</th> <th>49580A</th> <th>49580A -LF</th> <th>49580A -NB</th> <th>49580A -LF-NB</th> </tr> </thead> <tbody> <tr> <td>2" - 4"</td> <td>\$2,944.00</td> <td>\$2,407.00</td> <td>\$4,377.00</td> <td>\$3,839.00</td> </tr> </tbody> </table> <p><b>ADD FOR OPTIONS:</b></p> <table> <tbody> <tr><td>-3</td><td>\$0.00</td><td>-45</td><td>Deduct \$86.00</td></tr> <tr><td>-4</td><td>0.00</td><td>-51</td><td>0.00</td></tr> <tr><td>-7</td><td>256.00</td><td>-52</td><td>Deduct 411.00</td></tr> <tr><td>-8</td><td>270.00</td><td>-55**</td><td>270.00</td></tr> <tr><td>-16 (ARE)</td><td>543.00</td><td>-C</td><td>268.00</td></tr> <tr><td>-16 (NB)</td><td>608.00</td><td>-LF</td><td>Deduct 538.00</td></tr> <tr><td>-17 (ARE)</td><td>699.00</td><td>-LG (ARE)</td><td>Deduct 375.00</td></tr> <tr><td>-17 (NB)</td><td>899.00</td><td>-LG (NB)</td><td>Deduct 728.00</td></tr> <tr><td>-18 (ARE)</td><td>756.00</td><td>-NB</td><td>1,432.00</td></tr> <tr><td>-18 (NB)</td><td>1,259.00</td><td>-TSI</td><td>POA</td></tr> <tr><td>-31</td><td>446.00</td><td>-VP (NB)</td><td>110.00</td></tr> <tr><td>-33</td><td>776.00</td><td>-X</td><td>0.00</td></tr> <tr><td>-35*</td><td>671.00</td><td>-Z</td><td>0.00</td></tr> <tr><td>-43</td><td>446.00</td><td></td><td></td></tr> </tbody> </table> <p>* Specify -31 or -33 Bucket</p> <p>** 88450 Provided</p>	LIST PRICE					PIPE SIZE	49580A	49580A -LF	49580A -NB	49580A -LF-NB	2" - 4"	\$2,944.00	\$2,407.00	\$4,377.00	\$3,839.00	-3	\$0.00	-45	Deduct \$86.00	-4	0.00	-51	0.00	-7	256.00	-52	Deduct 411.00	-8	270.00	-55**	270.00	-16 (ARE)	543.00	-C	268.00	-16 (NB)	608.00	-LF	Deduct 538.00	-17 (ARE)	699.00	-LG (ARE)	Deduct 375.00	-17 (NB)	899.00	-LG (NB)	Deduct 728.00	-18 (ARE)	756.00	-NB	1,432.00	-18 (NB)	1,259.00	-TSI	POA	-31	446.00	-VP (NB)	110.00	-33	776.00	-X	0.00	-35*	671.00	-Z	0.00	-43	446.00			 <p><b>49850</b></p>	<p><b>12" ROUND FLUSHING RIM TOP</b></p> <table border="1"> <thead> <tr> <th colspan="2">LIST PRICE</th> </tr> <tr> <th>PIPE SIZE</th> <th>49850</th> </tr> </thead> <tbody> <tr> <td>2", 3"* 4", 6"</td> <td>\$3,742.00 3,742.00</td> </tr> </tbody> </table> <p><b>ADD FOR OPTIONS:</b></p> <table> <tbody> <tr><td>-13</td><td>\$141.00</td><td>-C</td><td>\$270.00</td></tr> <tr><td>-14</td><td>412.00</td><td>-TSI†</td><td>POA</td></tr> <tr><td>-51</td><td>0.00</td><td>-VP</td><td>0.00</td></tr> <tr><td>-98</td><td>8,026.00</td><td>-X</td><td>0.00</td></tr> <tr><td></td><td></td><td>-Z (6")</td><td>0.00</td></tr> </tbody> </table> <p>*The 49852 and 49853 use a 49854 Body with a Reducing Coupling.</p> <p>†Available up to 4" only</p>	LIST PRICE		PIPE SIZE	49850	2", 3"* 4", 6"	\$3,742.00 3,742.00	-13	\$141.00	-C	\$270.00	-14	412.00	-TSI†	POA	-51	0.00	-VP	0.00	-98	8,026.00	-X	0.00			-Z (6")	0.00
LIST PRICE																																																																																																				
PIPE SIZE	49580A	49580A -LF	49580A -NB	49580A -LF-NB																																																																																																
2" - 4"	\$2,944.00	\$2,407.00	\$4,377.00	\$3,839.00																																																																																																
-3	\$0.00	-45	Deduct \$86.00																																																																																																	
-4	0.00	-51	0.00																																																																																																	
-7	256.00	-52	Deduct 411.00																																																																																																	
-8	270.00	-55**	270.00																																																																																																	
-16 (ARE)	543.00	-C	268.00																																																																																																	
-16 (NB)	608.00	-LF	Deduct 538.00																																																																																																	
-17 (ARE)	699.00	-LG (ARE)	Deduct 375.00																																																																																																	
-17 (NB)	899.00	-LG (NB)	Deduct 728.00																																																																																																	
-18 (ARE)	756.00	-NB	1,432.00																																																																																																	
-18 (NB)	1,259.00	-TSI	POA																																																																																																	
-31	446.00	-VP (NB)	110.00																																																																																																	
-33	776.00	-X	0.00																																																																																																	
-35*	671.00	-Z	0.00																																																																																																	
-43	446.00																																																																																																			
LIST PRICE																																																																																																				
PIPE SIZE	49850																																																																																																			
2", 3"* 4", 6"	\$3,742.00 3,742.00																																																																																																			
-13	\$141.00	-C	\$270.00																																																																																																	
-14	412.00	-TSI†	POA																																																																																																	
-51	0.00	-VP	0.00																																																																																																	
-98	8,026.00	-X	0.00																																																																																																	
		-Z (6")	0.00																																																																																																	
 <p><b>49700</b></p>	<p><b>4" x 8" RECTANGULAR TOP, 4" DEEP</b></p> <table border="1"> <thead> <tr> <th colspan="5">LIST PRICE</th> </tr> <tr> <th>PIPE SIZE</th> <th>49700</th> <th>49700 -LF</th> <th>49700 -NB</th> <th>49700 -LF-NB</th> </tr> </thead> <tbody> <tr> <td>2", 3"</td> <td>\$2,608.00</td> <td>\$2,337.00</td> <td>\$3,077.00</td> <td>\$2,805.00</td> </tr> </tbody> </table> <p><b>ADD FOR OPTIONS:</b></p> <table> <tbody> <tr><td>-3</td><td>\$0.00</td><td>-52</td><td>Deduct \$237.00</td></tr> <tr><td>-4</td><td>0.00</td><td>-55*</td><td>270.00</td></tr> <tr><td>-7</td><td>256.00</td><td>-C</td><td>268.00</td></tr> <tr><td>-8</td><td>270.00</td><td>-LF</td><td>Deduct 270.00</td></tr> <tr><td>-16 (ARE)</td><td>543.00</td><td>-LG (ARE)</td><td>Deduct 213.00</td></tr> <tr><td>-16 (NB)</td><td>608.00</td><td>-LG (NB)</td><td>Deduct 432.00</td></tr> <tr><td>-30</td><td>671.00</td><td>-NB</td><td>466.00</td></tr> <tr><td>-43</td><td>446.00</td><td>-TSI</td><td>POA</td></tr> <tr><td>-45</td><td>Deduct 86.00</td><td>-VP (NB)</td><td>110.00</td></tr> <tr><td>-51</td><td>0.00</td><td>-X</td><td>0.00</td></tr> </tbody> </table> <p>* 88450 Provided</p>	LIST PRICE					PIPE SIZE	49700	49700 -LF	49700 -NB	49700 -LF-NB	2", 3"	\$2,608.00	\$2,337.00	\$3,077.00	\$2,805.00	-3	\$0.00	-52	Deduct \$237.00	-4	0.00	-55*	270.00	-7	256.00	-C	268.00	-8	270.00	-LF	Deduct 270.00	-16 (ARE)	543.00	-LG (ARE)	Deduct 213.00	-16 (NB)	608.00	-LG (NB)	Deduct 432.00	-30	671.00	-NB	466.00	-43	446.00	-TSI	POA	-45	Deduct 86.00	-VP (NB)	110.00	-51	0.00	-X	0.00	 <p><b>49870A</b></p>	<p><b>12" SQUARE CAN WASH DRAIN</b></p> <table border="1"> <thead> <tr> <th colspan="2">LIST PRICE</th> </tr> <tr> <th>PIPE SIZE</th> <th>49870A</th> </tr> </thead> <tbody> <tr> <td>3", 4"</td> <td>\$7,275.00</td> </tr> </tbody> </table> <p><b>ADD FOR OPTIONS:</b></p> <table> <tbody> <tr><td>-35</td><td>\$419.00</td><td>-C</td><td>\$268.00</td></tr> <tr><td>-51</td><td>0.00</td><td>-TSI</td><td>POA</td></tr> <tr><td>-55*</td><td>270.00</td><td>-VP</td><td>110.00</td></tr> <tr><td>-98</td><td>8,026.00</td><td>-X</td><td>0.00</td></tr> <tr><td></td><td></td><td>-Z</td><td>0.00</td></tr> </tbody> </table> <p>* 88450 Provided</p>	LIST PRICE		PIPE SIZE	49870A	3", 4"	\$7,275.00	-35	\$419.00	-C	\$268.00	-51	0.00	-TSI	POA	-55*	270.00	-VP	110.00	-98	8,026.00	-X	0.00			-Z	0.00																
LIST PRICE																																																																																																				
PIPE SIZE	49700	49700 -LF	49700 -NB	49700 -LF-NB																																																																																																
2", 3"	\$2,608.00	\$2,337.00	\$3,077.00	\$2,805.00																																																																																																
-3	\$0.00	-52	Deduct \$237.00																																																																																																	
-4	0.00	-55*	270.00																																																																																																	
-7	256.00	-C	268.00																																																																																																	
-8	270.00	-LF	Deduct 270.00																																																																																																	
-16 (ARE)	543.00	-LG (ARE)	Deduct 213.00																																																																																																	
-16 (NB)	608.00	-LG (NB)	Deduct 432.00																																																																																																	
-30	671.00	-NB	466.00																																																																																																	
-43	446.00	-TSI	POA																																																																																																	
-45	Deduct 86.00	-VP (NB)	110.00																																																																																																	
-51	0.00	-X	0.00																																																																																																	
LIST PRICE																																																																																																				
PIPE SIZE	49870A																																																																																																			
3", 4"	\$7,275.00																																																																																																			
-35	\$419.00	-C	\$268.00																																																																																																	
-51	0.00	-TSI	POA																																																																																																	
-55*	270.00	-VP	110.00																																																																																																	
-98	8,026.00	-X	0.00																																																																																																	
		-Z	0.00																																																																																																	
 <p><b>49720</b></p>	<p><b>6" x 12" RECTANGULAR TOP, 7" DEEP</b></p> <table border="1"> <thead> <tr> <th colspan="5">LIST PRICE</th> </tr> <tr> <th>PIPE SIZE</th> <th>49720</th> <th>49720 -LF</th> <th>49720 -NB</th> <th>49720 -LF-NB</th> </tr> </thead> <tbody> <tr> <td>3", 4", 6"</td> <td>\$3,471.00</td> <td>\$3,077.00</td> <td>\$4,170.00</td> <td>\$3,774.00</td> </tr> </tbody> </table> <p><b>ADD FOR OPTIONS:</b></p> <table> <tbody> <tr><td>-LF</td><td>Deduct \$395.00</td><td>-16 (NB)</td><td>\$608.00</td></tr> <tr><td>-NB</td><td>699.00</td><td>-18 (ARE)</td><td>756.00</td></tr> <tr><td>-LG (ARE)</td><td>Deduct 270.00</td><td>-18 (NB)</td><td>1,255.00</td></tr> <tr><td>-LG (NB)</td><td>Deduct 485.00</td><td>-30</td><td>671.00</td></tr> <tr><td>-3</td><td>0.00</td><td>-43</td><td>446.00</td></tr> <tr><td>-4</td><td>0.00</td><td>-45</td><td>Deduct 86.00</td></tr> <tr><td>-7</td><td>256.00</td><td>-51</td><td>0.00</td></tr> <tr><td>-8</td><td>270.00</td><td>-52</td><td>Deduct 411.00</td></tr> <tr><td>-TSI†</td><td>POA</td><td>-55*</td><td>270.00</td></tr> <tr><td>-VP (NB)</td><td>110.00</td><td>-C</td><td>268.00</td></tr> <tr><td>-16 (ARE)</td><td>543.00</td><td>-X</td><td>0.00</td></tr> </tbody> </table> <p>* 88450 Provided 3" &amp; 4". Body Primer Tapped for 6".</p> <p>† Available up to 4" only</p>	LIST PRICE					PIPE SIZE	49720	49720 -LF	49720 -NB	49720 -LF-NB	3", 4", 6"	\$3,471.00	\$3,077.00	\$4,170.00	\$3,774.00	-LF	Deduct \$395.00	-16 (NB)	\$608.00	-NB	699.00	-18 (ARE)	756.00	-LG (ARE)	Deduct 270.00	-18 (NB)	1,255.00	-LG (NB)	Deduct 485.00	-30	671.00	-3	0.00	-43	446.00	-4	0.00	-45	Deduct 86.00	-7	256.00	-51	0.00	-8	270.00	-52	Deduct 411.00	-TSI†	POA	-55*	270.00	-VP (NB)	110.00	-C	268.00	-16 (ARE)	543.00	-X	0.00	<p><b>Option Descriptions</b></p> <ul style="list-style-type: none"> <li>-C Clamp Device</li> <li>-LF Less Flange</li> <li>-LG Less Grate</li> <li>-NB Nickel Bronze Traffic Top</li> <li>-TSI Trap Seal Insert</li> <li>-VP Secured Grate, Vandal-Proof Screws</li> <li>-3 1/2 Grate</li> <li>-4 3/4 Grate</li> <li>-7 Full Grate with 2-1/2" Center Opening</li> <li>-8 Stainless Steel Depressed Grate</li> <li>-13 One-Piece Satin Nikaloy Grate</li> <li>-14 Loose-Set Satin Nikaloy Grate</li> <li>-16 Grate with 4" Round Funnel</li> <li>-17 Grate with 6" Round Funnel</li> <li>-18 Grate with 9" x 3-1/2" Oval Funnel</li> <li>-30 Stainless Steel Sediment Bucket</li> <li>-31 Sediment Bucket (Aluminum)</li> <li>-33 Sediment Bucket (A.R. Finish)</li> <li>-35 Stainless Steel Mesh Bucket Liner</li> <li>-43 Internal Dome Strainer (A.R. Finish)</li> <li>-45 Less Internal Dome Strainer</li> <li>-51 Galvanized Cast Iron Inside and Outside</li> <li>-52 Painted Inside and Outside</li> <li>-55 1/2" Primer Tap or Adapter</li> <li>-98 Water Supply Control Box</li> </ul> <p><b>Outlets</b></p> <ul style="list-style-type: none"> <li>-X Inside Caulk Outlet</li> <li>-Z No-Hub Outlet</li> </ul>																																							
LIST PRICE																																																																																																				
PIPE SIZE	49720	49720 -LF	49720 -NB	49720 -LF-NB																																																																																																
3", 4", 6"	\$3,471.00	\$3,077.00	\$4,170.00	\$3,774.00																																																																																																
-LF	Deduct \$395.00	-16 (NB)	\$608.00																																																																																																	
-NB	699.00	-18 (ARE)	756.00																																																																																																	
-LG (ARE)	Deduct 270.00	-18 (NB)	1,255.00																																																																																																	
-LG (NB)	Deduct 485.00	-30	671.00																																																																																																	
-3	0.00	-43	446.00																																																																																																	
-4	0.00	-45	Deduct 86.00																																																																																																	
-7	256.00	-51	0.00																																																																																																	
-8	270.00	-52	Deduct 411.00																																																																																																	
-TSI†	POA	-55*	270.00																																																																																																	
-VP (NB)	110.00	-C	268.00																																																																																																	
-16 (ARE)	543.00	-X	0.00																																																																																																	

# SS RETROFIT LINERS FOR SANITARY FLOOR SINKS



A WATTS Brand



STAINLESS STEEL RETROFIT LINER				
NOM. PIPE SIZE	TOP SIZE	GRATE TYPE	BODY DEPTH	LIST PRICE
2"	8"	Reinforced Perforated	6"	POA
3"	8"	Reinforced Perforated	6"	POA
4"	8"	Reinforced Perforated	6"	POA
2"	12"	Reinforced Perforated	6"	POA
3"	12"	Reinforced Perforated	6"	POA
4"	12"	Reinforced Perforated	6"	POA
2"	12"	Reinforced Perforated	8"	POA
3"	12"	Reinforced Perforated	8"	POA
4"	12"	Reinforced Perforated	8"	POA
2"	12"	Reinforced Perforated	10"	POA
3"	12"	Reinforced Perforated	10"	POA
4"	12"	Reinforced Perforated	10"	POA
2"	16"	Reinforced Perforated	6"	POA
3"	16"	Reinforced Perforated	6"	POA
4"	16"	Reinforced Perforated	6"	POA
6"	16"	Reinforced Perforated	6"	POA
8"	16"	Reinforced Perforated	6"	POA
2"	16"	Reinforced Perforated	12"	POA
3"	16"	Reinforced Perforated	12"	POA
4"	16"	Reinforced Perforated	12"	POA
6"	16"	Reinforced Perforated	12"	POA
8"	16"	Reinforced Perforated	12"	POA

**ADD FOR OPTIONS:**

DESCRIPTION	LIST ADD	LIST ADD	LIST ADD	LIST ADD	LIST ADD	LIST ADD
BENT EDGE	POA	POA	POA	POA	POA	POA
BENT EDGE - for 4" Pipe Size	N/A	N/A	N/A	POA	N/A	N/A
BENT EDGE - for 6" Pipe Size	N/A	N/A	N/A	N/A	POA	POA
3/4 GRATE	N/C	N/C	N/C	N/C	N/C	N/C
1/2 GRATE	N/C	N/C	N/C	N/C	N/C	N/C
No Grate	(POA)	(POA)	(POA)	(POA)	(POA)	(POA)
Anti-Slip Mesh Grate	N/A	POA	POA	POA	POA	POA
Perimeter Slot Plate Grate	POA	POA	POA	POA	POA	POA
Ladder Grate	POA	POA	POA	POA	POA	POA
Filter Basket	POA	POA	POA	POA	POA	POA
Solid Bucket	POA	POA	POA	POA	POA	POA
Secured Grate	POA	POA	POA	POA	POA	POA
316L Stainless Steel	PLUS 20%	PLUS 20%	PLUS 20%	PLUS 20%	PLUS 20%	PLUS 20%

For part numbers and pricing on Josam's Stainless Steel Retrofit Liners please refer to the Stainless Steel Drains Price Guide.

	<b>LEVELEZE® KLEENATRON® II SPECIAL-DUTY</b>																																																																		
	<b>LIST PRICE</b>																																																																		
	<b>PIPE SIZE</b>	<b>55000</b>	<b>55000-1 55000-2</b>	<b>55000-1-12 55000-2-12</b>	<b>55000-1-SQ 55000-2-SQ</b>	<b>55000-SS 55000-SS-SQ</b>	<b>55000-1-SD 55000-2-SD</b>	<b>55000-1-13 55000-2-13</b>																																																											
	2"	\$733.00	\$901.00	\$901.00	\$901.00	\$1,558.00	\$1,119.00	\$1,350.00																																																											
	3"	837.00	949.00	949.00	949.00	1,608.00	1,174.00	1,454.00																																																											
	4"	992.00	1,269.00	1,269.00	1,269.00	1,925.00	1,489.00	1,777.00																																																											
	5" (Z)	1,736.00	2,065.00	2,065.00	2,065.00	2,725.00	2,291.00	2,625.00																																																											
	6" (Z)	1,736.00	2,065.00	2,065.00	2,065.00	2,725.00	2,291.00	2,625.00																																																											
	<b>ADD FOR OPTIONS:</b>																																																																		
	<table border="0"> <tr> <td>-1 .....</td><td>ABOVE</td><td>-5 .....</td><td>\$439.00</td><td>-F .....</td><td>\$137.00</td> </tr> <tr> <td>-1-12 .....</td><td>ABOVE</td><td>-14 .....</td><td>112.00</td><td>-GC .....</td><td>437.00</td> </tr> <tr> <td>-1-13 .....</td><td>ABOVE</td><td>-22 (2" - 4") .....</td><td>273.00</td><td>-SS .....</td><td>ABOVE</td> </tr> <tr> <td>-1-SD .....</td><td>ABOVE</td><td>-22 (5" - 6") .....</td><td>877.00</td><td>-SS-SD** .....</td><td>777.00</td> </tr> <tr> <td>-1-SQ .....</td><td>ABOVE</td><td>-31 .....</td><td>314.00</td><td>-SS-SQ .....</td><td>ABOVE</td> </tr> <tr> <td>-2 .....</td><td>ABOVE</td><td>-41 .....</td><td>153.00</td><td>-WF* .....</td><td>674.00</td> </tr> <tr> <td>-2-12 .....</td><td>ABOVE</td><td>-ARE .....</td><td>505.00</td><td>-X .....</td><td>0.00</td> </tr> <tr> <td>-2-13 .....</td><td>ABOVE</td><td>-CFC .....</td><td>411.00</td><td>-Y .....</td><td>0.00</td> </tr> <tr> <td>-2-SD .....</td><td>ABOVE</td><td>-DBCL (4"X, 6"Z) .....</td><td>89.00</td><td>-Z .....</td><td>0.00</td> </tr> <tr> <td>-2-SQ .....</td><td>ABOVE</td><td>-DBCS .....</td><td>87.00</td><td>-VP .....</td><td>137.00</td> </tr> </table>								-1 .....	ABOVE	-5 .....	\$439.00	-F .....	\$137.00	-1-12 .....	ABOVE	-14 .....	112.00	-GC .....	437.00	-1-13 .....	ABOVE	-22 (2" - 4") .....	273.00	-SS .....	ABOVE	-1-SD .....	ABOVE	-22 (5" - 6") .....	877.00	-SS-SD** .....	777.00	-1-SQ .....	ABOVE	-31 .....	314.00	-SS-SQ .....	ABOVE	-2 .....	ABOVE	-41 .....	153.00	-WF* .....	674.00	-2-12 .....	ABOVE	-ARE .....	505.00	-X .....	0.00	-2-13 .....	ABOVE	-CFC .....	411.00	-Y .....	0.00	-2-SD .....	ABOVE	-DBCL (4"X, 6"Z) .....	89.00	-Z .....	0.00	-2-SQ .....	ABOVE	-DBCS .....	87.00	-VP .....
-1 .....	ABOVE	-5 .....	\$439.00	-F .....	\$137.00																																																														
-1-12 .....	ABOVE	-14 .....	112.00	-GC .....	437.00																																																														
-1-13 .....	ABOVE	-22 (2" - 4") .....	273.00	-SS .....	ABOVE																																																														
-1-SD .....	ABOVE	-22 (5" - 6") .....	877.00	-SS-SD** .....	777.00																																																														
-1-SQ .....	ABOVE	-31 .....	314.00	-SS-SQ .....	ABOVE																																																														
-2 .....	ABOVE	-41 .....	153.00	-WF* .....	674.00																																																														
-2-12 .....	ABOVE	-ARE .....	505.00	-X .....	0.00																																																														
-2-13 .....	ABOVE	-CFC .....	411.00	-Y .....	0.00																																																														
-2-SD .....	ABOVE	-DBCL (4"X, 6"Z) .....	89.00	-Z .....	0.00																																																														
-2-SQ .....	ABOVE	-DBCS .....	87.00	-VP .....	137.00																																																														
*Not Available on Cast Iron				**When choosing option -SS-SD, the price should be added to the 55000-SS List Price shown above.																																																															

  

	<b>SPANNER TYPE FLOOR CLEANOUT</b>																
	<b>LIST PRICE</b>																
	<b>PIPE SIZE</b>	<b>2"</b>	<b>3"</b>	<b>4"</b>	<b>5"</b>	<b>6"</b>											
		\$705.00	\$977.00	1,085.00	\$1,706.00	\$1,867.00											
<b>ADD FOR OPTIONS:</b>																	
<table border="0"> <tr> <td>-2 .....</td><td>Deduct \$110.00</td> <td>-24 .....</td><td>\$213.00</td> </tr> <tr> <td>-14 .....</td><td>112.00</td> <td>-ARE .....</td><td>505.00</td> </tr> <tr> <td></td><td></td> <td>-X .....</td><td>0.00</td> </tr> </table>						-2 .....	Deduct \$110.00	-24 .....	\$213.00	-14 .....	112.00	-ARE .....	505.00			-X .....	0.00
-2 .....	Deduct \$110.00	-24 .....	\$213.00														
-14 .....	112.00	-ARE .....	505.00														
		-X .....	0.00														

  

	<b>FLOOR CLEANOUT</b>																													
	<b>LIST PRICE</b>																													
	<b>PIPE SIZE</b>	<b>2", 3"</b>	<b>4"</b>																											
		\$1,407.00	\$1,458.00																											
<b>ADD FOR OPTIONS:</b>																														
<table border="0"> <tr> <td>-1 .....</td><td>\$574.00</td> <td>-20 .....</td><td>\$0.00</td> </tr> <tr> <td>-2 .....</td><td>495.00</td> <td>-31 .....</td><td>638.00</td> </tr> <tr> <td>-6 .....</td><td>462.00</td> <td>-ARE .....</td><td>505.00</td> </tr> <tr> <td>-6-1 .....</td><td>1,036.00</td> <td>-AE .....</td><td>340.00</td> </tr> <tr> <td>-6-2 .....</td><td>957.00</td> <td>-VP .....</td><td>213.00</td> </tr> <tr> <td>-12 .....</td><td>510.00</td> <td>-X .....</td><td>0.00</td> </tr> <tr> <td>-14 .....</td><td>112.00</td> <td></td><td></td> </tr> </table>			-1 .....	\$574.00	-20 .....	\$0.00	-2 .....	495.00	-31 .....	638.00	-6 .....	462.00	-ARE .....	505.00	-6-1 .....	1,036.00	-AE .....	340.00	-6-2 .....	957.00	-VP .....	213.00	-12 .....	510.00	-X .....	0.00	-14 .....	112.00		
-1 .....	\$574.00	-20 .....	\$0.00																											
-2 .....	495.00	-31 .....	638.00																											
-6 .....	462.00	-ARE .....	505.00																											
-6-1 .....	1,036.00	-AE .....	340.00																											
-6-2 .....	957.00	-VP .....	213.00																											
-12 .....	510.00	-X .....	0.00																											
-14 .....	112.00																													

  

	<b>LEVELEZE® KLEENATRON® SPECIAL-DUTY CAST IRON TOP 57008-Z-CI Standard</b>																																	
	<b>LIST PRICE</b>																																	
	<b>PIPE SIZE</b>	<b>8"</b>	<b>\$2,023.00</b>																															
	<b>ADD FOR OPTIONS:</b>																																	
<table border="0"> <tr> <td>-1 .....</td><td>\$331.00</td> <td>-14 .....</td><td>\$112.00</td> </tr> <tr> <td>-1-12 .....</td><td>336.00</td> <td>-31 .....</td><td>308.00</td> </tr> <tr> <td>-1-SD .....</td><td>557.00</td> <td>-ARE .....</td><td>505.00</td> </tr> <tr> <td>-1-SQ .....</td><td>331.00</td> <td>-CFC .....</td><td>411.00</td> </tr> <tr> <td>-2 .....</td><td>248.00</td> <td>-DBC .....</td><td>154.00</td> </tr> <tr> <td>-2-12 .....</td><td>248.00</td> <td>-LT .....</td><td>Deduct 902.00</td> </tr> <tr> <td>-2-SD .....</td><td>476.00</td> <td>-VP .....</td><td>134.00</td> </tr> <tr> <td>-2-SQ .....</td><td>248.00</td> <td>-Z .....</td><td>STD</td> </tr> </table>			-1 .....	\$331.00	-14 .....	\$112.00	-1-12 .....	336.00	-31 .....	308.00	-1-SD .....	557.00	-ARE .....	505.00	-1-SQ .....	331.00	-CFC .....	411.00	-2 .....	248.00	-DBC .....	154.00	-2-12 .....	248.00	-LT .....	Deduct 902.00	-2-SD .....	476.00	-VP .....	134.00	-2-SQ .....	248.00	-Z .....	STD
-1 .....	\$331.00	-14 .....	\$112.00																															
-1-12 .....	336.00	-31 .....	308.00																															
-1-SD .....	557.00	-ARE .....	505.00																															
-1-SQ .....	331.00	-CFC .....	411.00																															
-2 .....	248.00	-DBC .....	154.00																															
-2-12 .....	248.00	-LT .....	Deduct 902.00																															
-2-SD .....	476.00	-VP .....	134.00																															
-2-SQ .....	248.00	-Z .....	STD																															

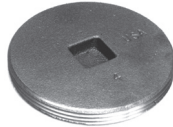

	<b>THREADED BRONZE PLUG</b>								
	<b>LIST PRICE</b>								
	<b>PIPE SIZE</b>	<b>1"</b>	<b>1-1/4"</b>	<b>1-1/2"</b>	<b>2"</b>	<b>2-1/2"</b>	<b>3"</b>		
		60.00	60.00	60.00	78.00	97.00	134.00		
<b>PIPE SIZE</b>	<b>3-1/2"</b>	<b>4"</b>	<b>5"</b>	<b>6"</b>	<b>8"</b>	<b>*10"</b>			
	223.00	249.00	371.00	510.00	1,029.00	1,515.00			
<b>ADD FOR OPTIONS:</b>									
<table border="0"> <tr> <td>-19 .....</td><td>\$65.00</td> <td>-20 .....</td><td>\$0.00</td> </tr> </table>						-19 .....	\$65.00	-20 .....	\$0.00
-19 .....	\$65.00	-20 .....	\$0.00						
*For 10" Size, Specify 58549-20. 10" Size Available with Raised Head Plug Only									

  

	<b>DEBRIS COVER</b>		
	<b>LIST PRICE</b>		
	<b>SERIES</b>	<b>COVER</b>	<b>ADD FOR OPTION:</b>
	55000	-DBCS	\$89.00
55004-X	-DBCL	89.00	
55006-Z	-DBCL	89.00	
57008	-DBC	154.00	

  

	<b>ADJUSTABLE FLOOR CLEANOUT</b>																				
	<b>LIST PRICE</b>																				
	<b>PIPE SIZE</b>	<b>2"</b>	<b>3"</b>	<b>4"</b>	<b>5"</b>	<b>6"</b>															
		\$711.00	\$815.00	\$932.00	1,050.00	1,071.00															
<b>ADD FOR OPTIONS:</b>																					
<table border="0"> <tr> <td>-2 .....</td><td>Deduct \$53.00</td> <td>-VP .....</td><td>\$134.00</td> </tr> <tr> <td>-31 .....</td><td>128.00</td> <td>-Y .....</td><td>0.00</td> </tr> <tr> <td>-14 .....</td><td>112.00</td> <td>-Z .....</td><td>0.00</td> </tr> <tr> <td>-ARE .....</td><td>505.00</td> <td></td><td></td> </tr> </table>						-2 .....	Deduct \$53.00	-VP .....	\$134.00	-31 .....	128.00	-Y .....	0.00	-14 .....	112.00	-Z .....	0.00	-ARE .....	505.00		
-2 .....	Deduct \$53.00	-VP .....	\$134.00																		
-31 .....	128.00	-Y .....	0.00																		
-14 .....	112.00	-Z .....	0.00																		
-ARE .....	505.00																				

  

	<b>ACCESS HOUSING AND COVER</b>																											
	<b>LIST PRICE</b>																											
	<b>PIPE SIZE</b>	<b>58580</b>	<b>58580-1 58580-1-SQ</b>	<b>58580-2</b>	<b>58580-5</b>																							
	2"	\$434.00	\$596.00	\$542.00	\$866.00																							
3", 4"	605.00	842.00	769.00	1,038.00																								
5", 6"	800.00	1,066.00	1,008.00	1,233.00																								
<b>ADD FOR OPTIONS:</b>																												
<table border="0"> <tr> <td>-1 (2") .....</td><td>\$163.00</td> <td>-5 .....</td><td>\$434.00</td> </tr> <tr> <td>-1 (3", 4") .....</td><td>237.00</td> <td>-14 .....</td><td>112.00</td> </tr> <tr> <td>-1 (5", 6") .....</td><td>267.00</td> <td>-SD .....</td><td>226.00</td> </tr> <tr> <td>-2 (2") .....</td><td>110.00</td> <td>-SQ (2") .....</td><td>163.00</td> </tr> <tr> <td>-2 (3", 4") .....</td><td>163.00</td> <td>-SQ (3", 4") .....</td><td>237.00</td> </tr> <tr> <td>-2 (5", 6") .....</td><td>210.00</td> <td>-SQ (5", 6") .....</td><td>267.00</td> </tr> </table>					-1 (2") .....	\$163.00	-5 .....	\$434.00	-1 (3", 4") .....	237.00	-14 .....	112.00	-1 (5", 6") .....	267.00	-SD .....	226.00	-2 (2") .....	110.00	-SQ (2") .....	163.00	-2 (3", 4") .....	163.00	-SQ (3", 4") .....	237.00	-2 (5", 6") .....	210.00	-SQ (5", 6") .....	267.00
-1 (2") .....	\$163.00	-5 .....	\$434.00																									
-1 (3", 4") .....	237.00	-14 .....	112.00																									
-1 (5", 6") .....	267.00	-SD .....	226.00																									
-2 (2") .....	110.00	-SQ (2") .....	163.00																									
-2 (3", 4") .....	163.00	-SQ (3", 4") .....	237.00																									
-2 (5", 6") .....	210.00	-SQ (5", 6") .....	267.00																									



	<b>WALL ACCESS COVER</b>		
	<b>LIST PRICE</b>		
<b>TYPE NO.</b>	<b>58604</b>	<b>58606</b>	<b>58608</b>
	\$200.00	\$249.00	\$678.00
<b>ADD FOR OPTIONS:</b>			
-17 .....	\$26.00	-COT6 .....	\$1,800.00
-20* .....	0.00	-PLG1-1/2 .....	60.00
-31** .....	226.00	-PLG2 .....	78.00
-CO2 .....	134.00	-PLG2-1/2 .....	97.00
-CO3 .....	213.00	-PLG3 .....	134.00
-CO4 .....	295.00	-PLG3-1/2 .....	223.00
-CO6 .....	603.00	-PLG4 .....	249.00
-COT2 .....	324.00	-PLG5 .....	371.00
-COT3 .....	405.00	-PLG6 .....	510.00
-COT4 .....	637.00	-VP .....	98.00
*Specify -PLG, -CO or -COT.			
**Specify -CO or -COT.			

	<b>WALL ACCESS COVER</b>		
	<b>LIST PRICE</b>		
<b>TYPE NO.</b>	<b>58642</b>	<b>58644</b>	<b>58646</b>
	\$863.00	\$1,269.00	\$1,368.00
<b>ADD FOR OPTIONS:</b>			
-2 (58642)Deduct	114.00	-CO3 .....	\$213.00
-2 (58644)Deduct	166.00	-CO4 .....	295.00
-2 (58646)Deduct	180.00	-CO6 .....	603.00
-10 .....	0.00	-COT2 .....	324.00
-2-10 .....	0.00	-COT3 .....	405.00
-20* .....	0.00	-COT4 .....	637.00
-31* .....	226.00	-COT6 .....	1,800.00
-CO2 .....	134.00	-VP .....	134.00
*Specify -CO or -COT.			

	<b>WALL OR FLOOR ACCESS COVER</b>		
	<b>LIST PRICE</b>		
<b>TYPE NO.</b>	<b>58614</b>	<b>58616</b>	<b>58618</b>
	\$510.00	\$876.00	\$1,262.00
<b>ADD FOR OPTIONS:</b>			
-2 (58614)Deduct	\$50.00	-CO3 .....	\$213.00
-2 (58616)Deduct	156.00	-CO4 .....	295.00
-2 (58618)Deduct	156.00	-CO6 .....	603.00
-10 .....	0.00	-COT2 .....	324.00
-14 .....	112.00	-COT3 .....	405.00
-20* .....	0.00	-COT4 .....	637.00
-31* .....	226.00	-COT6 .....	1,800.00
-CO2 .....	134.00	-VP .....	134.00
*Specify -CO or -COT.			

	<b>WALL OR FLOOR ACCESS COVER</b>		
	<b>LIST PRICE</b>		
<b>TYPE NO.</b>	<b>58624</b>	<b>58626</b>	
	\$1,175.00	\$1,526.00	
<b>ADD FOR OPTIONS:</b>			
-2 (58624)Deduct	\$80.00	-CO3 .....	\$213.00
-2 (58626)Deduct	166.00	-CO4 .....	295.00
-10 .....	0.00	-CO6 .....	603.00
-14 .....	112.00	-COT2 .....	324.00
-20* .....	0.00	-COT3 .....	405.00
-31* .....	226.00	-COT4 .....	637.00
-VP .....	134.00	-COT6 .....	1,800.00
-CO2 .....	134.00		
*Specify -CO or -COT.			





	<b>WALL OR FLOOR ACCESS COVER</b>		
	<b>LIST PRICE</b>		
<b>TYPE NO.</b>	<b>58631</b>	<b>58632</b>	
	\$1,138.00	\$1,677.00	
<b>ADD FOR OPTIONS:</b>			
-2 (58631)Deduct	110.00	-CO6 .....	\$603.00
-2 (58632)Deduct	180.00	-COT2 .....	324.00
-20* .....	0.00	-COT3 .....	405.00
-31* .....	226.00	-COT4 .....	637.00
-CO2 .....	134.00	-COT6 .....	1,800.00
-CO3 .....	213.00	-VP .....	134.00
-CO4 .....	295.00		
*Specify -CO or -COT.			

### Option Descriptions

- AE Adjustable Extension
- ARE Acid-Resisting Epoxy
- CFC Carpet Cleanout Flange Cover
- CO2 No-Hub Cleanout, 2"
- CO3 No-Hub Cleanout, 3"
- CO4 No-Hub Cleanout, 4"
- CO6 No-Hub Cleanout, 6"
- COT2 No-Hub Cleanout Tee, 2"
- COT3 No-Hub Cleanout Tee, 3"
- COT4 No-Hub Cleanout Tee, 4"
- COT6 No-Hub Cleanout Tee, 6"
- DBC Debris Cover
- DBCS Debris Cover Small
- DBCL Debris Cover Large
- F Flange Only
- GC Gasket Cover
- LT Less Top
- PLG Bronze N.P.T. Plug (Specify Plug Size)
- SS Stainless Steel Top
- SS-SD Stainless Steel, Special Duty Top
- SS-SQ Square Top, Stainless Steel
- VP Secured Cover, Vandal-Proof Screws
- WF Wide Flange (not available on CI)
- 1 Satin Finish Nikaloy Top
- 1-SD Special Duty Satin Finish Nikaloy Top
- 1-SQ Square Top, Satin Finish Nikaloy
- 1-12 Cover Recessed for Tile, Satin Finish Nikaloy
- 1-13 Terrazzo Tile Cover, Satin Finish Nikaloy
- 2 Satin Finish Bronze Top
- 2-SD Special Duty Satin Finish Bronze Top
- 2-SQ Square Top, Satin Finish Bronze
- 2-10 Satin Finish Bronze Scoriated Cover
- 2-12 Cover Recessed for Tile, Satin Finish Bronze
- 2-13 Terrazzo Tile Cover, Satin Finish Bronze
- 5 Ductile Iron Top
- 6 Square Top, Cast Iron
- 6-1 Square Top, Nikaloy
- 6-2 Square Top, Bronze
- 10 Scoriated Cover
- 11 Smooth Top
- 12 Cover Recessed for Tile
- 14 Carpet Cleanout Marker
- 19 Plug Tapped for Center Screw
- 20 Raised Head Bronze Plug
- 22 Taper Thread Bronze Plug
- 24 Spanner Wrench
- 31 Galvanized Cast Iron Parts
- 41 Clamp Ring and Flange

### Outlets

- X Inside Caulk Outlet
- Y Hub Outlet w/Gasket 2" - 4"
- Z No-Hub Outlet

<p><b>58650</b></p> 	<p><b>STAINLESS STEEL WALL ACCESS COVER</b></p> <table border="1"> <thead> <tr> <th colspan="3">LIST PRICE</th> </tr> <tr> <th>TYPE NO.</th> <th>58656</th> <th>\$1,269.00</th> </tr> </thead> <tbody> <tr> <td colspan="3"><b>ADD FOR OPTIONS:</b></td> </tr> <tr> <td>-20*</td> <td>\$0.00</td> <td>-COT2 .....\$324.00</td> </tr> <tr> <td>-31*</td> <td>227.00</td> <td>-COT3 .....405.00</td> </tr> <tr> <td>-CO2</td> <td>134.00</td> <td>-COT4 .....637.00</td> </tr> <tr> <td>-CO3</td> <td>213.00</td> <td>-COT6 .....1,800.00</td> </tr> <tr> <td>-CO4</td> <td>295.00</td> <td>-VP .....134.00</td> </tr> <tr> <td>-CO6</td> <td>603.00</td> <td></td> </tr> </tbody> </table> <p>*Specify -CO or -COT.</p>	LIST PRICE			TYPE NO.	58656	\$1,269.00	<b>ADD FOR OPTIONS:</b>			-20*	\$0.00	-COT2 .....\$324.00	-31*	227.00	-COT3 .....405.00	-CO2	134.00	-COT4 .....637.00	-CO3	213.00	-COT6 .....1,800.00	-CO4	295.00	-VP .....134.00	-CO6	603.00		<p><b>Cleanout Option Descriptions</b></p> <p>-ARE Acid-Resisting Epoxy</p> <p>-CO2 No-Hub Cleanout, 2"</p> <p>-CO3 No-Hub Cleanout, 3"</p> <p>-CO4 No-Hub Cleanout, 4"</p> <p>-CO6 No-Hub Cleanout, 6"</p> <p>-COT2 No-Hub Cleanout Tee, 2"</p> <p>-COT3 No-Hub Cleanout Tee, 3"</p> <p>-COT4 No-Hub Cleanout Tee, 4"</p> <p>-COT6 No-Hub Cleanout Tee, 6"</p> <p>-PLG1-1/2 Bronze NPT Plug, 1-1/2"</p> <p>-PLG2 Bronze NPT Plug, 2"</p> <p>-PLG2-1/2 Bronze NPT Plug, 2-1/2"</p> <p>-PLG3 Bronze NPT Plug, 3"</p> <p>-PLG3-1/2 Bronze NPT Plug, 3-1/2"</p> <p>-PLG4 Bronze NPT Plug, 4"</p> <p>-PLG5 Bronze NPT Plug, 5"</p> <p>-PLG6 Bronze NPT Plug, 6"</p> <p>-SD Special-Duty Top, Nikaloy</p> <p>-SQ Square Top</p> <p>-VP Secured Cover, Vandal-Proof Screws</p> <p>-1 Satin Finish Nikaloy Top</p> <p>-2 Satin Finish Bronze Top</p> <p>-5 Ductile Iron Top</p> <p>-10 Scoriated Cover</p> <p>-14 Carpet Cleanout Marker</p> <p>-17 Center Screw Longer than Standard</p> <p>-19 Plug Tapped for Center Screw</p> <p>-20 Raised Head Bronze Plug</p> <p>-26 Gasketed Cover</p> <p>-31 Galvanized Cast Iron Parts</p>
LIST PRICE																													
TYPE NO.	58656	\$1,269.00																											
<b>ADD FOR OPTIONS:</b>																													
-20*	\$0.00	-COT2 .....\$324.00																											
-31*	227.00	-COT3 .....405.00																											
-CO2	134.00	-COT4 .....637.00																											
-CO3	213.00	-COT6 .....1,800.00																											
-CO4	295.00	-VP .....134.00																											
-CO6	603.00																												
<p><b>58680</b></p> 	<p><b>ACCESS COVER</b></p> <table border="1"> <thead> <tr> <th colspan="3">LIST PRICE</th> </tr> <tr> <th>TYPE NO.</th> <th>58680</th> <th>\$1,994.00</th> </tr> </thead> <tbody> <tr> <td colspan="3"><b>ADD FOR OPTIONS:</b></td> </tr> <tr> <td>-1</td> <td>\$879.00</td> <td>-ARE .....\$505.00</td> </tr> <tr> <td>-2</td> <td>784.00</td> <td>-CO2 .....134.00</td> </tr> <tr> <td>-5</td> <td>662.00</td> <td>-CO3 .....213.00</td> </tr> <tr> <td>-20*</td> <td>0.00</td> <td>-CO4 .....295.00</td> </tr> <tr> <td>-26</td> <td>239.00</td> <td>-CO6 .....603.00</td> </tr> <tr> <td>-31</td> <td>800.00</td> <td>-VP .....134.00</td> </tr> </tbody> </table> <p>Special Wording on Cover, SAN. or STORM. Specify on Order .....\$212.00</p> <p>*Specify -CO or -COT.</p>	LIST PRICE			TYPE NO.	58680	\$1,994.00	<b>ADD FOR OPTIONS:</b>			-1	\$879.00	-ARE .....\$505.00	-2	784.00	-CO2 .....134.00	-5	662.00	-CO3 .....213.00	-20*	0.00	-CO4 .....295.00	-26	239.00	-CO6 .....603.00	-31	800.00	-VP .....134.00	<p>-SD Special-Duty Top, Nikaloy</p> <p>-SQ Square Top</p> <p>-VP Secured Cover, Vandal-Proof Screws</p> <p>-1 Satin Finish Nikaloy Top</p> <p>-2 Satin Finish Bronze Top</p> <p>-5 Ductile Iron Top</p> <p>-10 Scoriated Cover</p> <p>-14 Carpet Cleanout Marker</p> <p>-17 Center Screw Longer than Standard</p> <p>-19 Plug Tapped for Center Screw</p> <p>-20 Raised Head Bronze Plug</p> <p>-26 Gasketed Cover</p> <p>-31 Galvanized Cast Iron Parts</p>
LIST PRICE																													
TYPE NO.	58680	\$1,994.00																											
<b>ADD FOR OPTIONS:</b>																													
-1	\$879.00	-ARE .....\$505.00																											
-2	784.00	-CO2 .....134.00																											
-5	662.00	-CO3 .....213.00																											
-20*	0.00	-CO4 .....295.00																											
-26	239.00	-CO6 .....603.00																											
-31	800.00	-VP .....134.00																											
<p><b>58900</b></p> 	<p><b>NO-HUB CLEANOUT FERRULE</b></p> <table border="1"> <thead> <tr> <th colspan="5">LIST PRICE</th> </tr> <tr> <th>PIPE SIZE</th> <th>2"</th> <th>3"</th> <th>4"</th> <th>6"</th> </tr> </thead> <tbody> <tr> <td></td> <td>\$134.00</td> <td>\$213.00</td> <td>\$295.00</td> <td>\$603.00</td> </tr> </tbody> </table> <p><b>ADD FOR OPTIONS:</b></p> <p>-19 .....\$65.00    -31 .....\$226.00</p> <p>-20 .....0.00    -Z .....0.00</p>	LIST PRICE					PIPE SIZE	2"	3"	4"	6"		\$134.00	\$213.00	\$295.00	\$603.00	<p>-17 Center Screw Longer than Standard</p> <p>-19 Plug Tapped for Center Screw</p> <p>-20 Raised Head Bronze Plug</p> <p>-26 Gasketed Cover</p> <p>-31 Galvanized Cast Iron Parts</p>												
LIST PRICE																													
PIPE SIZE	2"	3"	4"	6"																									
	\$134.00	\$213.00	\$295.00	\$603.00																									
<p><b>58910</b></p> 	<p><b>NO-HUB CLEANOUT TEE w/PLUG</b></p> <table border="1"> <thead> <tr> <th colspan="5">LIST PRICE</th> </tr> <tr> <th>PIPE SIZE</th> <th>2"</th> <th>3"</th> <th>4"</th> <th>6"</th> </tr> </thead> <tbody> <tr> <td></td> <td>\$324.00</td> <td>\$405.00</td> <td>\$637.00</td> <td>\$1,800.00</td> </tr> </tbody> </table> <p><b>ADD FOR OPTIONS:</b></p> <p>-19 .....\$65.00    -31 .....\$226.00</p> <p>-20 .....0.00    -Z .....0.00</p>	LIST PRICE					PIPE SIZE	2"	3"	4"	6"		\$324.00	\$405.00	\$637.00	\$1,800.00	<p>Outlets</p> <p>-Z No-Hub Outlet</p>												
LIST PRICE																													
PIPE SIZE	2"	3"	4"	6"																									
	\$324.00	\$405.00	\$637.00	\$1,800.00																									

# GREASE INTERCEPTORS





A WATTS Brand

60100H	MANUAL CLEANING, ON-FLOOR TYPE														
	TYPE NO.	PIPE SIZE	FLOW RATE GPM	GR. CAP. LBS	LIST PRICE	FOR OPTIONS, ADD TO LIST PRICE									
						-40	-61	-ISI	-EXT 6"	Ea. Add'l Inch Ext.	-RT	-ET	-HD	-AC	
	60102H	2	7	14	\$5,009.00	N/A	N/A	\$2,837.00	N/A	N/A	10,546.00	\$12,161.00	\$8,836.00	\$1,955.00	
	60103H	2	10	20	5,886.00	\$8,144.00	2,731.00	2,837.00	7,300.00	364.00	10,968.00	12,739.00	9,503.00	1,955.00	
	60104H	2	15	30	8,713.00	9,879.00	2,731.00	2,837.00	7,404.00	410.00	11,766.00	13,878.00	10,218.00	1,955.00	
	60105H	3	20	40	10,669.00	11,050.00	2,731.00	2,837.00	7,404.00	464.00	12,521.00	14,961.00	10,824.00	2,739.00	
	60106H	3	25	50	11,986.00	12,771.00	3,049.00	2,912.00	7,404.00	520.00	12,787.00	15,467.00	11,418.00	2,739.00	
	60107H	3	35	70	14,814.00	15,677.00	3,169.00	3,295.00	8,967.00	575.00	12,787.00	16,860.00	12,620.00	2,739.00	
	60108H	3	50	100	19,618.00	21,797.00	3,598.00	4,923.00	9,699.00	671.00	14,173.00	17,754.00	13,225.00	2,739.00	
	60109H	3	75	150	40,321.00	POA	5,711.00	5,307.00	10,079.00	737.00	17,609.00	19,269.00	14,109.00	3,835.00	
	60110H	4	100	200	45,357.00	POA	6,384.00	5,812.00	11,423.00	841.00	27,999.00	29,660.00	18,816.00	3,835.00	
<b>ADD FOR OPTIONS:</b>															
	-40				ABOVE	-ET				ABOVE	-ISI				ABOVE
	-61				ABOVE	-EXT				ABOVE	-RT				ABOVE
	-85				\$218.00	-GRD				POA	-SS				POA
	-AC				ABOVE	-HD				ABOVE					
• PRICE ON APPLICATION															

60100-SA	SEMI-AUTOMATIC						
	TYPE NO.	PIPE SIZE	FLOW RATE GPM	GREASE CAP. LBS	LIST PRICE	FOR OPTIONS, ADD TO LIST PRICE	
						-RT	-ET
	60102-SA	2	7	14	\$12,865.00	\$10,318.00	\$12,641.00
	60103-SA	2	10	20	15,177.00	11,987.00	14,362.00
	60104-SA	2	15	30	16,172.00	13,315.00	15,971.00
	60105-SA	2	20	40	19,874.00	13,536.00	16,531.00
	60106-SA	3*	25	50	24,106.00	13,789.00	17,178.00
	60107-SA	3*	35	70	24,740.00	14,738.00	18,426.00
	60108-SA	3*	50	100	28,240.00	14,873.00	19,054.00
	60109-SA	3*	75	150	32,607.00	19,364.00	20,565.00
<b>ADD FOR OPTIONS:</b>							
	-62			\$0.00	-66	\$444.00	
	-65			317.00	-67	630.00	
					-85	\$218.00	
					-ET	ABOVE	
					-RT	ABOVE	
*3" Sizes Normally Furnished with 4" x 3" Reducing Bushings.							

## Grease Interceptor Option Descriptions

- |      |  |     |  |
|------|--|-----|--|
| -ET  | Enclosed Type                                    | -40 | Cover Recess for Floor Finish                      |
| -EXT | Extension, 6" Standard, Specify Extension Height | -61 | Flange and Clamp Device                            |
| -AC  | Aluminum Cover                                   | -62 | 4" Inlet and Outlet Available on Standard 3" Sizes |
| -HD  | Heavy-Duty Cover                                 | -65 | Hub Inlet, Spigot Outlet, 2                        |
| -ISI | Integrated Solids Interceptor                    | -66 | Hub Inlet, Spigot Outlet, 3                        |
| -RT  | Recessed Type                                    | -67 | Hub Inlet, Spigot Outlet, 4"                       |
| -SS  | Stainless Steel                                  | -85 | Enzymatic Port                                     |

<b>60110A</b> 	<b>MANUAL CLEANING, LOW TYPE</b>					<b>60115A-SA</b> 	<b>SEMI-AUTOMATIC, LOW TYPE</b>				
	TYPE NO.	PIPE SIZE	FLOW RATE GPM	GREASE CAP. LBS.	LIST PRICE		TYPE NO.	PIPE SIZE	FLOW RATE GPM	GREASE CAP. LBS.	LIST PRICE
	60115A	2*	20	40	\$14,414.00		60115A-SA	3	35	70	\$33,804.00
	60117A	3	35	70	18,562.00		<b>ADD FOR OPTIONS:</b>				
	<b>ADD FOR OPTIONS:</b>						-65 .....\$317.00    -66 .....\$428.00 -66 .....444.00    -85 .....218.00				
*2" Sizes Normally Furnished with 3" x 2" Reducing Bushings											

<b>60210A</b> 	<b>MANUAL CLEANING TYPE, HIGH VOLUME</b>										
	TYPE NO.	PIPE SIZE	FLOW RATE GPM	GREASE CAP. LBS.	LIST PRICE	-EXT 6"	Ea. Add'l Inch Ext.	-60	-61	-ISI	-HD
	60213A	4	150	300	\$49,493.00	\$5,878.00	\$454.00	\$4,516.00	\$7,270.00	\$5,592.00	\$22,240.00
	60214A	5	200	400	71,796.00	10,583.00	477.00	4,836.00	8,493.00	5,877.00	25,361.00
	60215A	5	250	500	83,578.00	13,147.00	513.00	6,451.00	11,457.00	6,201.00	35,014.00
	60216A	6	350	700	109,435.00	18,261.00	658.00	8,162.00	13,706.00	7,831.00	53,000.00
	60217A	6	500	1000	142,692.00	27,440.00	781.00	9,693.00	16,295.00	9,281.00	74,575.00
<b>ADD FOR OPTIONS:</b>											
-60 ..... ABOVE    -85 ..... \$218.00    -HD..... ABOVE -61 ..... ABOVE    -EXT ..... ABOVE    -ISI ..... ABOVE											

### Grease Interceptor Option Descriptions

- |      |  |     |  |
|------|--|-----|--|
| -EXT | Extension, 6" Standard, Specify Extension Height | -62 | 4" Inlet and Outlet Available on Standard 3" Sizes |
| -HD  | Heavy-Duty Cover                                 | -65 | Hub Inlet, Spigot Outlet, 2                        |
| -ISI | Integrated Solids Interceptor                    | -66 | Hub Inlet, Spigot Outlet, 3                        |
| -60  | Anchor Flange                                    | -68 | 3" Inlet and Outlet Avail on Std 2" Sizes          |
| -61  | Flange and Clamp Device                          | -85 | Enzymatic Port                                     |



60500B	DRAW-OFF, GRAVITY TYPE								
	TYPE NO.	PIPE SIZE	FLOW RATE GPM	LIST PRICE	FOR OPTIONS, ADD TO LIST PRICE				
					-EXT 6"	Ea. Add'l Inch Ext.	-60†	-61†	-HD
	60503B	2	10	\$8,046.00	\$7,533.00	\$331.00	\$2,055.00	\$2,469.00	\$8,567.00
	60504B	2	15	11,052.00	7,632.00	369.00	2,055.00	2,469.00	9,212.00
	60505B	3*	20	13,368.00	7,857.00	412.00	2,218.00	2,469.00	9,756.00
	60506B	3*	25	14,507.00	8,085.00	477.00	2,310.00	2,751.00	10,298.00
	60507B	3*	35	17,635.00	8,387.00	513.00	2,426.00	2,861.00	11,377.00
	60508B	3*	50	23,728.00	10,014.00	601.00	2,473.00	3,256.00	11,921.00
<b>ADD FOR OPTIONS:</b>									
-60 ..... ABOVE -EXT ..... ABOVE -HD..... ABOVE									
-61 ..... ABOVE									
* 3" Sizes Normally Furnished with 4" x 3" Reducing Bushings. †Only Available with -EXT Option									

60500-EST	DRAW-OFF, GRAVITY TYPE w/EXTERNAL STORAGE TANK									
	TYPE NO.	PIPE SIZE	FLOW RATE GPM	TANK CAP. GAL.	LIST PRICE	FOR OPTIONS, ADD TO LIST PRICE				
						-EXT 6"	Ea. Add'l Inch Ext.	-60	-61	-HD
	60503-EST-5	2	10	5	\$12,082.00	11,299.00	\$465.00	\$3,060.00	\$3,697.00	\$13,631.00
	60503-EST-50	2	10	50	17,076.00	12,994.00	539.00	3,513.00	4,246.00	15,677.00
	60504-EST-6	2	15	6	16,571.00	11,450.00	560.00	3,060.00	3,697.00	14,509.00
	60504-EST-50	2	15	50	18,018.00	13,176.00	641.00	3,513.00	4,246.00	16,691.00
	60505-EST-8	3*	20	8	20,052.00	11,799.00	637.00	3,060.00	3,697.00	15,359.00
	60505-EST-50	3*	20	50	22,197.00	13,569.00	734.00	3,513.00	4,246.00	17,659.00
	60506-EST-50	3*	25	50	21,748.00	11,904.00	697.00	3,469.00	4,044.00	15,918.00
	60506-EST-100	3*	25	100	24,203.00	12,495.00	714.00	3,469.00	4,044.00	17,509.00
	60507-EST-50	3*	35	50	26,441.00	12,327.00	756.00	3,545.00	4,182.00	16,753.00
	60507-EST-100	3*	35	100	28,897.00	12,951.00	773.00	3,545.00	4,182.00	18,416.00
	60508-EST-50	3*	50	50	29,966.00	14,070.00	860.00	3,604.00	4,787.00	16,011.00
	60508-EST-100	3*	50	100	34,956.00	14,692.00	879.00	3,604.00	4,787.00	17,597.00
<b>ADD FOR OPTIONS:</b>										
-19 .....\$3,332.00 -61 ..... ABOVE -HD..... ABOVE										
-60†..... ABOVE -EXT ..... ABOVE										
* 3" Sizes Normally Furnished with 4" x 3" Reducing Bushings. †Only Available with -EXT Option										



60610A	DRAW-OFF TYPE, HIGH VOLUME								
	TYPE NO.	PIPE SIZE	FLOW RATE GPM	LIST PRICE	FOR OPTIONS, ADD TO LIST PRICE				
					-EXT 6"	Ea. Add'l Inch Ext.	-60*	-61*	-HD
	60611A	3	75	\$41,104.00	\$5,645.00	\$369.00	\$2,450.00	\$4,885.00	\$12,591.00
	60612A	4	100	44,578.00	5,878.00	394.00	3,012.00	5,464.00	17,310.00
	60613A	4	150	55,193.00	6,351.00	454.00	4,205.00	6,776.00	22,240.00
	60614A	5	200	77,977.00	9,086.00	477.00	4,511.00	7,911.00	25,361.00
	60615A	5	250	90,307.00	11,815.00	513.00	6,026.00	10,257.00	35,014.00
	60616A	6	350	114,133.00	17,013.00	658.00	7,593.00	12,753.00	53,000.00
	60617A	6	500	165,814.00	26,490.00	781.00	9,013.00	15,177.00	74,575.00
<b>ADD FOR OPTIONS:</b>									
-60* ..... ABOVE -EXT ..... ABOVE -HD..... ABOVE									
-61* ..... ABOVE									
* Only Available with -EXT Option									

### Oil Separator Option Descriptions



- EXT    Extension, 6" Standard, Specify Extension Height
- HD    Heavy-Duty Cover
- 19    Reclaim Tank Alarm
- 60    Anchor Flange
- 61    Flange and Clamp Device

60610-EST	DRAW-OFF, GRAVITY TYPE w/EXTERNAL STORAGE TANK										
	TYPE NO.	PIPE SIZE	FLOW RATE GPM	TANK CAP. GAL	LIST PRICE	FOR OPTIONS, ADD TO LIST PRICE					
						-EXT 6"	Ea. Add'l Inch Ext.	-60*	-61*	-HD	
	60611-EST	3	75	100	\$60,550.00	\$8,298.00	\$560.00	\$3,985.00	\$7,210.00	\$18,504.00	
	60612-EST	4	100	250	66,883.00	8,817.00	601.00	4,557.00	8,178.00	25,992.00	
	60613-EST	4	150	250	82,785.00	9,513.00	684.00	6,302.00	10,146.00	33,349.00	
	60614-EST	5	200	250	109,624.00	12,797.00	684.00	6,741.00	11,859.00	35,712.00	
	60615-EST	5	250	500	126,979.00	16,601.00	743.00	8,451.00	14,388.00	49,070.00	
	60616-EST	6	350	500	160,511.00	23,930.00	924.00	10,664.00	17,899.00	70,940.00	
	60617-EST	6	500	500	221,426.00	35,593.00	1,089.00	12,690.00	21,324.00	104,806.00	
	<b>ADD FOR OPTIONS:</b>										
	-19 .....	\$3,332.00			-61* .....	ABOVE			-HD .....	ABOVE	
	-60 .....	ABOVE			-EXT .....	ABOVE					
	* Only Available with -Ext Option										
	<b>EXTERNAL STORAGE TANK NOT SHOWN</b>										



  

60810	OIL SEDIMENT INTERCEPTOR			61040A	SOLIDS INTERCEPTOR TOP ACCESS ON-FLOOR TRAP TYPE			
	TYPE NO.	PIPE SIZE	LIST PRICE		TYPE NO.	PIPE SIZE	LIST PRICE	
	60816	2	\$5,296.00		61042A	2	\$7,148.00	
	60817	4	14,283.00		61043A	3	7,148.00	
	60818	4	20,311.00		61044A	4	7,148.00	
	60819	4	30,098.00		<b>ADD FOR OPTIONS:</b>			
					-15 .....	\$1,761.00	-EXT* .....	\$1,214.00
					-16 .....	1,149.00		
					*6" Standard, Each Add'l. Inch..... \$134.00			

61000	SOLIDS INTERCEPTOR BOTTOM ACCESS FIXTURE TRAP TYPE				61070	SOLIDS INTERCEPTOR TOP ACCESS IN-LINE TYPE			
	TYPE NO.	INLET	OUTLET	LIST PRICE		TYPE NO.	PIPE SIZE	LIST PRICE	
	61001-1/4	1-1/4	1-1/2	\$2,486.00		61072	2	\$4,459.00	
	61001-1/2	1-1/2	1-1/2	2,486.00		61073	3	7,383.00	
						61074	4	10,288.00	
	<b>ADD FOR OPTIONS:</b>					-4 .....	\$1,765.00	-86 .....	\$0.00
	-1 .....	Deduct \$1,127.00		-30 .....	Deduct \$329.00				
	-3 .....	0.00		-CP .....	POA*				
	* PRICE ON APPLICATION								

61030-1	SOLIDS INTERCEPTOR CAST IRON TOP ACCESS FIXTURE TRAP TYPE			61080	SOLIDS INTERCEPTOR TOP ACCESS IN-LINE TYPE			
	TYPE NO.	PIPE SIZE	LIST PRICE		TYPE NO.	PIPE SIZE	LIST PRICE	
	61031-1/2-1	1-1/2	\$1,848.00		61084	4	\$17,454.00	
	61032-1	2	1,848.00		61085	5	17,454.00	
					61086	6	17,454.00	
	-26 .....	\$1,022.00	-30 .....	\$527.00				
					-4 .....	\$3,905.00	-86 .....	\$0.00
					-15 .....	\$2,860.00		

### Oil & Solids Interceptor Option Descriptions

-EXT	Extension, 6" Standard, Specify Extension Height	-16	Monel Screens
-HD	Heavy-Duty Cover	-19	Reclaim Tank Alarm
-CP	Chrome Plated Bronze	-26	Cast Aluminum
-1	Painted Cast Iron	-30	Acid-Resisting Cast Iron Inside and Outside
-3	Polished Bronze	-60	Anchor Flange
-4	Galvanized Cast Iron Parts	-61	Flange and Clamp Device
-15	Stainless Steel Basket	-86	Flat Bottom Basket

# SOLIDS INTERCEPTORS

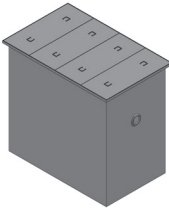

A WATTS Brand

	SAND INTERCEPTOR					
	TYPE NO.	CAPACITY CUBIC FT.	SIZE GALLONS	LIST PRICE	FOR OPTIONS, ADD TO LIST PRICE	
					-EXT UP TO 6"	-HD
	61091	45	340	\$60,753.00	\$1,846.00	\$2,371.00
	61092	54	400	89,615.00	2,266.00	2,980.00
	61093	72	540	POA●	POA●	POA●
	61094	81	610	POA●	POA●	POA●
	61095	90	670	POA●	POA●	POA●
61096	108	810	POA●	POA●	POA●	
61097	135	1,010	POA●	POA●	POA●	
ADD FOR OPTIONS:						
-EXT ..... ABOVE -HD..... ABOVE						
• PRICE ON APPLICATION						

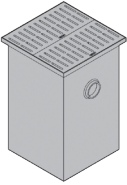
	SAND/SEDIMENT INTERCEPTOR										
	TYPE NO.	PIPE SIZE	FLOW RATE GPM	# OF GRATES	LIST PRICE	FOR OPTIONS, ADD TO LIST PRICE					
						-EXT 6"	Each Add'l Inch Ext.	-HD	-61	-7	-17-H20
	61103	4	20	2	\$18,971.00	\$1,164.00	\$130.00	\$3,645.00	\$3,170.00	\$3,892.00	\$5,790.00
	61104	4	50	4	32,172.00	1,807.00	192.00	7,290.00	5,711.00	7,784.00	11,002.00
	61105	4	150	8	97,223.00	3,232.00	332.00	14,587.00	8,493.00	15,567.00	25,290.00
	61106	6	250	12	135,031.00	4,859.00	494.00	26,326.00	13,706.00	23,353.00	36,855.00
	61107	8	500	20	180,949.00	8,238.00	834.00	36,450.00	16,295.00	38,920.00	57,016.00
ADD FOR OPTIONS:											
-61 ..... ABOVE -EXT ..... ABOVE -HD..... ABOVE											

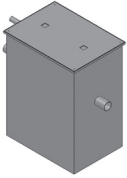
	RICE INTERCEPTOR		
	TYPE NO.	PIPE SIZE	LIST PRICE
	61202	3	POA●
	61203	4	POA●
	61204	4	POA●
	61205	4	POA●
	61207	6	POA●
	ADD FOR OPTIONS:		
-SS .....POA● -T.....NC			
• PRICE ON APPLICATION			

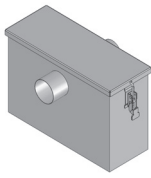
	SOLIDS INTERCEPTOR IN-LINE TYPE			
	TYPE NO.	PIPE SIZE	FLOW RATE GPM	LIST PRICE
	61303	3	50	POA●
	61304	4	100	POA●
	ADD FOR OPTIONS:			
	-SS .....POA●			
	• PRICE ON APPLICATION			

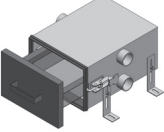

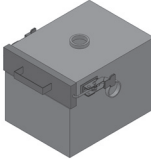



	SOLIDS INTERCEPTOR DRAWER TYPE, SIDE INLET		
	TYPE NO.	PIPE SIZE	LIST PRICE
	61402	2	\$11,906.00
	ADD FOR OPTIONS:		
	-316 .....\$2,380.00 -T.....POA●		
	• PRICE ON APPLICATION		

	SOLIDS INTERCEPTOR DRAWER TYPE, TOP INLET		
	TYPE NO.	PIPE SIZE	LIST PRICE
	61502	2	\$11,906.00
	ADD FOR OPTIONS:		
	-316 .....\$2,380.00 -T.....POA●		
	• PRICE ON APPLICATION		

	LINT INTERCEPTOR						
	TYPE NO.	PIPE SIZE	FLOW RATE GPM	MAX. NUMBER OF WASHERS	LIST PRICE	FOR OPTIONS, ADD TO LIST PRICE	
						-EXT 6"	Ea. Add'l Inch Ext.
	61805	3	70	7	\$18,499.00	\$6,675.00	\$416.00
	61806	4	200	20	26,337.00	6,675.00	469.00
	61807	6	300	30	30,624.00	8,085.00	519.00
	61808	6	400	40	34,919.00	8,744.00	605.00

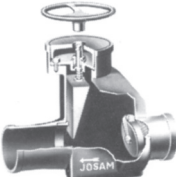
### Interceptors Option Descriptions

- |   |   |
|---|---|
| -316 Type 316 L Stainless Steel                             | -EXT Extension, 6" Standard, Specify Extension Height |
| -61 Flange and Clamp Device                                 | -HD Heavy-Duty Cover                                  |
| -7 Ductile Iron Grates                                      | -SS Stainless Steel                                   |
| -17-H20 Ductile Iron Grates with Additional Welded Supports | -T NPT Threaded Connections                           |

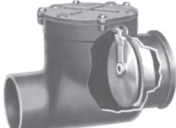
<p><b>67100A</b></p> 	<p><b>BALL-FLOAT ADAPTER TYPE</b></p> <table border="1"> <thead> <tr> <th colspan="3">LIST PRICE</th> </tr> <tr> <th>PIPE SIZE</th> <th>2", 3", 4"</th> <th>6"</th> </tr> </thead> <tbody> <tr> <td></td> <td>\$833.00</td> <td>\$1,728.00</td> </tr> </tbody> </table> <p><b>ADD FOR OPTIONS:</b></p> <table> <tr> <td>-5 (2"- 4") .....</td> <td>\$134.00</td> <td>-35 .....</td> <td>\$223.00</td> </tr> <tr> <td>-5 (6") .....</td> <td>340.00</td> <td></td> <td></td> </tr> </table>	LIST PRICE			PIPE SIZE	2", 3", 4"	6"		\$833.00	\$1,728.00	-5 (2"- 4") .....	\$134.00	-35 .....	\$223.00	-5 (6") .....	340.00			<p><b>67650</b></p> 	<p><b>COMBINED DRAIN/SWING-CHECK TYPE</b></p> <table border="1"> <thead> <tr> <th colspan="3">LIST PRICE</th> </tr> <tr> <th>PIPE SIZE</th> <th>3", 4"</th> <th>6"</th> </tr> </thead> <tbody> <tr> <td></td> <td>\$2,625.00</td> <td>\$3,951.00</td> </tr> </tbody> </table> <p><b>ADD FOR OPTIONS:</b></p> <table> <tr> <td>-1 (3", 4").....</td> <td>\$1,243.00</td> <td>-25 .....</td> <td>\$377.00</td> </tr> <tr> <td>-1 (6") .....</td> <td>1,080.00</td> <td>-LBV (3", 4") Ded.</td> <td>554.00</td> </tr> <tr> <td>-2 (3", 4").....</td> <td>833.00</td> <td>-LBV (6").....Ded.</td> <td>972.00</td> </tr> <tr> <td>-2 (6") .....</td> <td>688.00</td> <td>-VP .....</td> <td>208.00</td> </tr> <tr> <td>-5 .....</td> <td>833.00</td> <td></td> <td></td> </tr> </table>	LIST PRICE			PIPE SIZE	3", 4"	6"		\$2,625.00	\$3,951.00	-1 (3", 4").....	\$1,243.00	-25 .....	\$377.00	-1 (6") .....	1,080.00	-LBV (3", 4") Ded.	554.00	-2 (3", 4").....	833.00	-LBV (6").....Ded.	972.00	-2 (6") .....	688.00	-VP .....	208.00	-5 .....	833.00		
LIST PRICE																																																	
PIPE SIZE	2", 3", 4"	6"																																															
	\$833.00	\$1,728.00																																															
-5 (2"- 4") .....	\$134.00	-35 .....	\$223.00																																														
-5 (6") .....	340.00																																																
LIST PRICE																																																	
PIPE SIZE	3", 4"	6"																																															
	\$2,625.00	\$3,951.00																																															
-1 (3", 4").....	\$1,243.00	-25 .....	\$377.00																																														
-1 (6") .....	1,080.00	-LBV (3", 4") Ded.	554.00																																														
-2 (3", 4").....	833.00	-LBV (6").....Ded.	972.00																																														
-2 (6") .....	688.00	-VP .....	208.00																																														
-5 .....	833.00																																																
<p><b>67360</b></p> 	<p><b>SHEAR-GATE &amp; SWING-CHECK TYPE</b></p> <table border="1"> <thead> <tr> <th colspan="3">LIST PRICE</th> </tr> <tr> <th>PIPE SIZE</th> <th>67360</th> <th>67360-DH</th> </tr> </thead> <tbody> <tr> <td>3", 4"</td> <td>\$7,209.00</td> <td>\$7,209.00</td> </tr> <tr> <td>5", 6"</td> <td>10,613.00</td> <td>10,613.00</td> </tr> </tbody> </table> <p><b>ADD FOR OPTIONS:</b></p> <table> <tr> <td>-15 .....</td> <td>\$0.00</td> <td>-29 (3", 4").....</td> <td>\$4,158.00</td> </tr> <tr> <td>-28 (3", 4").....</td> <td>2,972.00</td> <td>-29 (5", 6").....</td> <td>4,550.00</td> </tr> <tr> <td>-28 (5", 6").....</td> <td>3,408.00</td> <td>-DH.....</td> <td>0.00</td> </tr> </table>	LIST PRICE			PIPE SIZE	67360	67360-DH	3", 4"	\$7,209.00	\$7,209.00	5", 6"	10,613.00	10,613.00	-15 .....	\$0.00	-29 (3", 4").....	\$4,158.00	-28 (3", 4").....	2,972.00	-29 (5", 6").....	4,550.00	-28 (5", 6").....	3,408.00	-DH.....	0.00	<p><b>67720</b></p> 	<p><b>HUB INLET, SWING-CHECK TYPE</b></p> <table border="1"> <thead> <tr> <th colspan="3">LIST PRICE</th> </tr> <tr> <th>PIPE SIZE</th> <th>3"</th> <th>4"</th> </tr> </thead> <tbody> <tr> <td></td> <td>\$780.00</td> <td>\$1,133.00</td> </tr> </tbody> </table> <p><b>ADD FOR OPTIONS:</b></p> <table> <tr> <td>-15 .....</td> <td>\$0.00</td> </tr> </table>	LIST PRICE			PIPE SIZE	3"	4"		\$780.00	\$1,133.00	-15 .....	\$0.00											
LIST PRICE																																																	
PIPE SIZE	67360	67360-DH																																															
3", 4"	\$7,209.00	\$7,209.00																																															
5", 6"	10,613.00	10,613.00																																															
-15 .....	\$0.00	-29 (3", 4").....	\$4,158.00																																														
-28 (3", 4").....	2,972.00	-29 (5", 6").....	4,550.00																																														
-28 (5", 6").....	3,408.00	-DH.....	0.00																																														
LIST PRICE																																																	
PIPE SIZE	3"	4"																																															
	\$780.00	\$1,133.00																																															
-15 .....	\$0.00																																																
<p><b>67400</b></p> 	<p><b>NO-HUB SWING-CHECK TYPE</b></p> <table border="1"> <thead> <tr> <th colspan="5">LIST PRICE</th> </tr> <tr> <th>PIPE SIZE</th> <th>2"</th> <th>3"</th> <th>4"</th> <th>6"</th> </tr> </thead> <tbody> <tr> <td></td> <td>\$1,867.00</td> <td>\$2,922.00</td> <td>\$3,597.00</td> <td>\$4,599.00</td> </tr> </tbody> </table>	LIST PRICE					PIPE SIZE	2"	3"	4"	6"		\$1,867.00	\$2,922.00	\$3,597.00	\$4,599.00	<p><b>67800</b></p> 	<p><b>HUB INLET, SWING-CHECK TYPE</b></p> <table border="1"> <thead> <tr> <th colspan="3">LIST PRICE</th> </tr> <tr> <th>PIPE SIZE</th> <th>6"</th> <th>8"</th> </tr> </thead> <tbody> <tr> <td></td> <td>\$3,233.00</td> <td>\$3,934.00</td> </tr> </tbody> </table> <p><b>ADD FOR OPTIONS:</b></p> <table> <tr> <td>-4 .....</td> <td>\$1,138.00</td> <td>-15 .....</td> <td>\$0.00</td> </tr> </table>	LIST PRICE			PIPE SIZE	6"	8"		\$3,233.00	\$3,934.00	-4 .....	\$1,138.00	-15 .....	\$0.00																		
LIST PRICE																																																	
PIPE SIZE	2"	3"	4"	6"																																													
	\$1,867.00	\$2,922.00	\$3,597.00	\$4,599.00																																													
LIST PRICE																																																	
PIPE SIZE	6"	8"																																															
	\$3,233.00	\$3,934.00																																															
-4 .....	\$1,138.00	-15 .....	\$0.00																																														
<p><b>67500</b></p> 	<p><b>HUB &amp; SPIGOT SWING-CHECK TYPE</b></p> <table border="1"> <thead> <tr> <th colspan="4">LIST PRICE</th> </tr> <tr> <th>PIPE SIZE</th> <th>2"</th> <th>3"</th> <th>4"</th> </tr> </thead> <tbody> <tr> <td></td> <td>\$1,867.00</td> <td>\$2,922.00</td> <td>\$3,597.00</td> </tr> <tr> <th>PIPE SIZE</th> <th>6"</th> <th>8"</th> <th></th> </tr> <tr> <td></td> <td>\$5,169.00</td> <td>\$7,261.00</td> <td></td> </tr> </tbody> </table> <p><b>ADD FOR OPTIONS:</b></p> <table> <tr> <td>-5 (2"- 4") .....</td> <td>\$754.00</td> <td>-15 .....</td> <td>\$0.00</td> </tr> <tr> <td>-5 (6"- 8") .....</td> <td>1,890.00</td> <td>-30 .....</td> <td>583.00</td> </tr> <tr> <td>-10* .....</td> <td>0.00</td> <td></td> <td></td> </tr> </table> <p>* For Extension, Use -10 Option with Hub and Spigot Extension Pipe by Others.</p>	LIST PRICE				PIPE SIZE	2"	3"	4"		\$1,867.00	\$2,922.00	\$3,597.00	PIPE SIZE	6"	8"			\$5,169.00	\$7,261.00		-5 (2"- 4") .....	\$754.00	-15 .....	\$0.00	-5 (6"- 8") .....	1,890.00	-30 .....	583.00	-10* .....	0.00			<p><b>Backwater Valve Option Descriptions</b></p> <ul style="list-style-type: none"> <li>-DH Double Hub</li> <li>-LBV Less Backwater Valve</li> <li>-VP Secured Face, Vandal-Proof Screws</li> <li>-1 Satin Finish Nikaloy Face</li> <li>-2 Satin Finish Bronze Face</li> <li>-4 Bronze Seat</li> <li>-5 Galvanized Cast Iron Parts</li> <li>-10 Threaded Bronze Cover</li> <li>-15 Open Flap</li> <li>-25 Flashing Clamp Device</li> <li>-28 12" Cast Iron Extension and Stem</li> <li>-29 24" Cast Iron Extension and Stem</li> <li>-30 2" Auxiliary Inlet with Bronze Plug</li> <li>-35 1/2" Primer Tap</li> </ul>															
LIST PRICE																																																	
PIPE SIZE	2"	3"	4"																																														
	\$1,867.00	\$2,922.00	\$3,597.00																																														
PIPE SIZE	6"	8"																																															
	\$5,169.00	\$7,261.00																																															
-5 (2"- 4") .....	\$754.00	-15 .....	\$0.00																																														
-5 (6"- 8") .....	1,890.00	-30 .....	583.00																																														
-10* .....	0.00																																																
<p><b>67600</b></p> 	<p><b>HUB &amp; SPIGOT SWING-CHECK TYPE</b></p> <table border="1"> <thead> <tr> <th colspan="3">LIST PRICE</th> </tr> <tr> <th>TYPE NO.</th> <th>PIPE SIZE</th> <th></th> </tr> </thead> <tbody> <tr> <td>67610</td> <td>10"</td> <td>\$11,861.00</td> </tr> <tr> <td>67612</td> <td>12"</td> <td>15,390.00</td> </tr> </tbody> </table> <p><b>ADD FOR OPTIONS:</b></p> <table> <tr> <td>-15 .....</td> <td>\$0.00</td> </tr> </table>	LIST PRICE			TYPE NO.	PIPE SIZE		67610	10"	\$11,861.00	67612	12"	15,390.00	-15 .....	\$0.00																																		
LIST PRICE																																																	
TYPE NO.	PIPE SIZE																																																
67610	10"	\$11,861.00																																															
67612	12"	15,390.00																																															
-15 .....	\$0.00																																																



	<b>71300</b>			<b>QUARTER-TURN HYDRANT, BOX TYPE FOR NSF/ANSI 61</b>		
	<b>LIST PRICE</b>					
	<b>SIZE</b>					
	6-1/4	71300-6-QTR	\$2,206.00			
	7-1/4	71300-7-QTR	2,206.00			
	9-1/4	71300-9-QTR	2,284.00			
	11-1/4	71300-11-QTR	2,284.00			
	13-1/4	71300-13-QTR	2,284.00			
	15-1/4	71300-15-QTR	2,403.00			
	17-1/4	71300-17-QTR	2,403.00			
<b>ADD FOR OPTIONS:</b>						
-52*	\$86.00	-91	\$301.00			
-54*	391.00	-95	301.00			
-72	0.00	-HD	1,767.00			
-74	130.00	-HD-52	1,852.00			
-81	200.00	-HD-54	1,767.00			
*SS Box Body						

	<b>71600</b>			<b>YARD HYDRANT, BOX TYPE NON-FREEZE</b>		
	<b>LIST PRICE</b>					
	<b>SIZE</b>		<b>71600 3/4" Connection</b>		<b>71600-91 1" Connection</b>	
	2' Bury	\$2,873.00	\$3,327.00			
	3' Bury	3,091.00	3,556.00			
	4' Bury	3,305.00	3,791.00			
	5' Bury	3,546.00	4,004.00			
	<b>ADD FOR OPTIONS:</b>					
	-52	\$0.00	-91	ABOVE		
	-80	2,901.00	-95	301.00		
-81*	200.00	-97	265.00			
*Requires -80						

	<b>71350</b>			<b>QUARTER-TURN HYDRANT FOR NSF/ANSI 61</b>		
	<b>LIST PRICE</b>					
	<b>SIZE</b>					
	3	71350-MC-QTR	\$1,240.00			
	4	71350-4-QTR	1,240.00			
	6	71350-6-QTR	1,240.00			
	8	71350-8-QTR	1,240.00			
	10	71350-10-QTR	1,313.00			
	12	71350-12-QTR	1,313.00			
	14	71350-14-QTR	1,313.00			
<b>ADD FOR OPTIONS:</b>						
-72	\$0.00	-81	\$200.00			
-74	131.00	-91	301.00			
-EPCP	132.00					

	<b>71650</b>			<b>TRI-TEMP WALL HYDRANT, BOX TYPE NON-FREEZE</b>		
	<b>LIST PRICE</b>					
	<b>SIZE</b>		<b>71650 3/4" Connection</b>		<b>71650-91 1" Connection</b>	
	6", 8" Wall	\$5,447.00	\$6,045.00			
	10", 12", 14" Wall	5,605.00	6,201.00			
	16", 18" Wall	6,082.00	6,681.00			
	20", 22", 24" Wall	6,388.00	6,986.00			
	<b>ADD FOR OPTIONS:</b>					
	-72	\$0.00	-81	\$200.00		
	-73	0.00	-91	ABOVE		
-74	130.00	-95	301.00			

	<b>71400</b>			<b>YARD HYDRANT NON-FREEZE</b>		
	<b>LIST PRICE</b>					
	<b>SIZE</b>		<b>3/4" CONNECTION</b>			
	2' Bury	\$1,662.00				
	3' Bury	1,751.00				
	4' Bury	1,846.00				
	5' Bury	1,934.00				
	6' Bury	2,021.00				

	<b>71450</b>			<b>YARD HYDRANT, HEAVY-DUTY NON-FREEZE</b>		
	<b>LIST PRICE</b>					
	<b>SIZE</b>		<b>71450 3/4" Connection</b>		<b>71450 1" Connection</b>	
	2' Bury	\$2,018.00	\$3,445.00			
	3' Bury	2,313.00	3,565.00			
	4' Bury	2,424.00	3,710.00			
	5' Bury	2,532.00	3,851.00			
	6' Bury	2,620.00	3,951.00			

### Hydrant Option Descriptions

- 52 Satin Finish Bronze Face, SS Box
- 54 Satin Finish Nikaloy Face, SS Box
- 72 Wall Clamp
- 73 Solder Inlet Adapter
- 74 Union Elbow Assembly
- 80 Deep Box
- 81 Vacuum Breaker
- 91 1" Hose Pipe Threaded Outlet
- 95 Cylinder Vandal-Proof Lock
- 97 1/8" Tapped Drain Hole in Box
- EPCP Escutcheon Plate, Chrome-Plated
- HD Heavy Duty
- HD-52 Heavy Duty Box, Satin Finish Bronze Face
- HD-54 Heavy Duty Box, Satin Finish Nikaloy Face

**SHOCK ABSORBERS**

75000



**STAINLESS STEEL SHELL & ADAPTER**

LIST PRICE	
SIZE	
A	\$791.00
B	1,596.00
C	2,399.00
D	6,004.00
E	6,777.00
F	8,331.00

**TRENCH DRAINS**

76000



**SUPER-FLO<sup>®</sup> 6" WIDE, RECTANGULAR**

LIST PRICE			
PIPE SIZE	2", 3", 4"	\$1,486.00	
<b>ADD FOR OPTIONS:</b>			
-1 .....	\$1,590.00	-ARE .....	\$918.00
-2 .....	1,371.00	-EXT .....	1,486.00
-7 .....	462.00	-VP .....	340.00
-30 .....	223.00	-X .....	0.00
-40 .....	460.00		

2" and 3" Provided as 4" -X with Reducer.

76010



**12" WIDE, RECTANGULAR**

LIST PRICE			
PIPE SIZE	3"- 6"	\$3,485.00	
<b>ADD FOR OPTIONS:</b>			
-1 .....	\$1,967.00	-70 .....	\$810.00
-2 .....	1,693.00	-70-40 .....	1,316.00
-7 .....	1,269.00	-ARE .....	1,836.00
-11 .....	268.00	-EXT .....	3,485.00
-30 .....	213.00	-VP .....	340.00
-40 .....	920.00	-X .....	0.00

3" Provided as 4" -X with Reducer.

76200



**FRAME & GRATE ASSEMBLY (C CLASS)**

TYPE NO.	OVERALL WIDTH	LIST PRICE
76210	6"	POA●
76220	10"	POA●

• PRICE ON APPLICATION

76300

76400

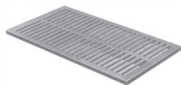

**LIGHT-DUTY RECTANGULAR TRENCH DRAIN & ADDITIONAL SECTIONS**

LIST PRICE						
OPTIONS	76300 20" GRATE	76301 SINGLE GRATE & FRAME	76302 2-GRATE SECTION	76302 ADD'L. 20" 1-GRATE SECTION	76402 24" 2-GRATE SECTION	7640 ADD'L. 12" SECTIONS
	\$815.00	\$1,784.00	\$3,568.00	\$1,784.00	\$3,976.00	\$1,316.00
<b>ADD FOR OPTIONS:</b>						
-1	\$3,060.00	\$4,912.00	\$7,784.00	\$2,873.00	\$8,094.00	\$4,054.00
-7	902.00	1,803.00	3,611.00	1,803.00	3,611.00	1,803.00
-8-2	2,728.00	4,297.00	6,842.00	2,553.00	7,136.00	3,719.00
-40	460.00	699.00	1,394.00	699.00	1,394.00	670.00
-VP	N/A	671.00	1,347.00	671.00	1,347.00	671.00

76500

76600

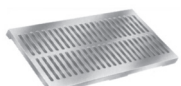

**MEDIUM-DUTY RECTANGULAR TRENCH DRAIN & ADDITIONAL SECTIONS**

LIST PRICE						
OPTIONS	76500 24" GRATE	76501 SINGLE GRATE & FRAME	76502 2-GRATE SECTION	76502 ADD'L. 24" 1-GRATE SECTION	76602 24" 2-GRATE SECTION	7660 ADD'L. 12" SECTIONS
	\$1,038.00	\$2,816.00	\$4,345.00	\$2,730.00	\$5,202.00	\$2,385.00
<b>ADD FOR OPTIONS:</b>						
-1	\$3,889.00	\$5,588.00	\$9,928.00	\$4,345.00	\$11,636.00	\$6,044.00
-7	1,800.00	1,800.00	3,603.00	1,800.00	3,603.00	1,800.00
-8-2	3,613.00	5,073.00	8,980.00	3,909.00	10,443.00	5,370.00
-40	1,969.00	1,969.00	3,938.00	1,969.00	3,938.00	1,969.00
-VP	N/A	671.00	1,347.00	671.00	1,347.00	671.00

**TRENCH DRAINS (cont'd)**

76700  
76800



**HEAVY-DUTY RECTANGULAR TRENCH DRAIN & ADDITIONAL SECTIONS**

LIST PRICE						
OPTIONS	76700 24" GRATE	76701 SINGLE GRATE & FRAME	76702 2-GRATE SECTION	76702 ADD'L. 24" 1-GRATE SECTION	76802 24" 2-GRATE SECTION	7680 ADD'L. 12" SECTIONS
	\$1,833.00	\$3,793.00	\$6,621.00	\$2,828.00	\$5,515.00	\$2,398.00
<b>ADD FOR OPTIONS:</b>						
-1	\$5,909.00	\$9,287.00	\$17,541.00	\$8,251.00	\$15,160.00	\$6,286.00
-7	1,946.00	1,946.00	3,888.00	1,946.00	3,888.00	1,946.00
-8-2	5,464.00	8,162.00	15,651.00	7,496.00	13,441.00	5,632.00
-40	1,843.00	2,208.00	4,419.00	2,208.00	4,419.00	2,208.00
-VP	N/A	671.00	1,347.00	671.00	1,347.00	671.00

**Trench Drain Option Descriptions**

- ARE Acid Resistant Coating on Cast Iron Parts
- EXT Extension Section
- VP \* Secured Grate, Vandal-Proof Screws
- 1 Satin Finish Nikaloy Top
- 2 Satin Finish Bronze Top
- 7 Ductile Iron Grate
- 8-2 All Bronze with Satin Finish Top
- 11 Convex Grate
- 30 Flashing Clamp Device
- 40 Galvanized Cast Iron Parts
- 70 Sediment Bucket
- 70-40 Sediment Bucket, Galvanized
- Outlet
- X Inside Caulk Outlet

\* For Installations Exposed to Vehicular Traffic, Specify -VP, Secured Grate

**MISCELLANEOUS PRODUCTS**

85220



**5" x 7" 90° ANGLE STRAINER**

LIST PRICE			
PIPE SIZE	2", 3", 4"	\$2,368.00	
<b>ADD FOR OPTIONS:</b>			
-3	\$966.00	-47	\$842.00
-41	395.00	-T	0.00
-42	268.00	-VP	249.00

85810



**RECTANGULAR PATTERN DRAIN**

LIST PRICE			
PIPE SIZE	2", 3", 4"	\$699.00	
<b>ADD FOR OPTIONS:</b>			
-1	\$863.00	-T	\$112.00
-2	774.00	-TSI	POA
-3	953.00	-VP	208.00
-42	212.00	-X	0.00
-47	707.00		

85800



**RECTANGULAR PATTERN DRAIN**

LIST PRICE			
PIPE SIZE	4", 5", 6"	\$966.00	
<b>ADD FOR OPTIONS:</b>			
-1	\$1,405.00	-47	\$842.00
-2	1,259.00	-T	0.00
-3	953.00	-TSI	POA
-42	212.00	-VP	208.00

85903-Z













**CAST IRON DRAIN  
w/MEDIUM-DUTY SLOTTED GRATE**

LIST PRICE			
PIPE SIZE	3"	\$233.00	
<b>ADD FOR OPTIONS:</b>			
-47	\$171.00	-TSI	POA
-F4-93	277.00	-Z	STD

**Miscellaneous Product Option Descriptions**

- F4-93 Round Cast Iron Funnel
- TSI Trap Seal Insert
- VP Secured Grate, Vandal-Proof Screws
- 1 Satin Finish Nikaloy Top
- 2 Satin Finish Bronze Top
- 3 Chrome Plated Bronze Face
- 41 Clamp Device
- 42 Ground Screw
- 47 Galvanized Cast Iron Parts
- Outlets
- T Threaded Outlet
- X Inside Caulk Outlet
- Z No-Hub Outlet

<b>F52 &amp; F53</b> 	<b>CAST IRON THREADED FUNNEL</b>		<b>88270</b> 	<b>PLASTIC PIPE SLEEVE</b>		
	<b>LIST PRICE</b>			<b>LIST PRICE</b>		
	<b>F52</b> \$466.00	<b>F53</b> \$623.00		<b>MODEL</b>	<b>SLEEVE SIZE</b>	
				<b>88273</b>	<b>3"</b>	\$19.00
				<b>88274</b>	<b>4"</b>	27.00
				<b>88276</b>	<b>6"</b>	36.00
				<b>88278</b>	<b>8"</b>	59.00
<b>88100</b> 	<b>P TRAP</b>		<b>88300</b> 	<b>TRAP SEAL PRIMER VALVE</b>		
	<b>LIST PRICE</b>			<b>LIST PRICE</b>		
	<b>PIPE SIZE</b>			<b>88300</b>	<b>POA</b>	
	<b>2"</b> \$633.00 <b>3"</b> 966.00 <b>4"</b> 1,436.00			88280 Less Distribution Unit..... \$1,939.00		
<b>ADD FOR OPTIONS:</b>			• PRICE ON APPLICATION			
	-51 .....\$213.00	-60 .....\$291.00				
<b>88210</b> 	<b>DEEP SEAL TRAP, FUNNEL INLET</b>		<b>88400</b> 	<b>NO-HUB SPIGOT ADAPTER</b>		
	<b>LIST PRICE</b>			<b>LIST PRICE</b>		
	<b>PIPE SIZE</b>			<b>PIPE SIZE</b>		
	<b>2"</b> \$1,050.00 <b>3"</b> 1,214.00			<b>2"</b> \$134.00 <b>3"</b> 197.00 <b>4"</b> 313.00 <b>6"</b> 953.00 <b>8"</b> 1,067.00		
<b>ADD FOR OPTIONS:</b>			<b>ADD FOR OPTIONS:</b>			
	-8 (2") .....\$820.00	-51 .....\$213.00	-40 .....\$122.00	-50 .....\$213.00		
	-8 (3") .....1,824.00	-72 .....291.00	-49 .....213.00			
		-ARE .....411.00				
<b>88240</b> 	<b>TSI® - TRAP SEAL INSERT</b>		<b>88450</b> 	<b>TRAP PRIMER ADAPTER</b>		
	<b>LIST PRICE</b>			<b>LIST PRICE</b>		
	<b>MODEL</b>	<b>PIPE SIZE</b>				
	<b>88242</b> <b>88243</b> <b>88243-1/2</b> <b>88244</b>	<b>2"</b> <b>3"</b> <b>3-1/2"</b> <b>4"</b>		<b>POA</b> <b>POA</b> <b>POA</b> <b>POA</b>		
<b>ADD FOR OPTIONS:</b>			<b>ADD FOR OPTIONS:</b>			
<b>88250</b> 	<b>TRAP SEAL PRIMER VALVE</b>		<b>88550</b> 	<b>HUB ADAPTER, THREADED OUTLET</b>		
	<b>LIST PRICE</b>			<b>LIST PRICE</b>		
	<b>88250</b> \$416.00			<b>PIPE SIZE</b>		
<b>ADD FOR OPTIONS:</b>			<b>3"</b> \$213.00 <b>4"</b> 270.00 <b>5"</b> 560.00 <b>6"</b> 671.00			
	-10 .....\$122.00		<b>ADD FOR OPTIONS:</b>			
			-40 (3", 4") .....\$98.00	-40 (6") .....\$171.00		
			-40 (5") .....148.00			





	88560 HUB ADAPTER, THREADED OUTLET	
	LIST PRICE	
	PIPE SIZE	
	2"	\$134.00
	3"	256.00
4"	340.00	
5"	560.00	
6"	652.00	
8"	1,193.00	
<b>ADD FOR OPTIONS:</b>		
-40 (2"- 4") .....\$112.00    -40 (5"- 8").....\$174.00		

	88950 FRESH AIR INLET	
	LIST PRICE	
	PIPE SIZE	
	2", 3", 4"	\$822.00
	5", 6"	1,405.00
8"	2,239.00	
<b>ADD FOR OPTIONS:</b>		
-2 (2" - 4")..Deduct \$126.00		
-2 (5", 6")..Deduct \$301.00		
-2 (8").....Deduct \$532.00		

	88600 REDUCING HUB ADAPTER		
	LIST PRICE		
	TYPE NO.	PIPE SIZE	
	88603-2	2"	\$351.00
	88604-2	2"	371.00
88604-2-1/2	2-1/2"	371.00	
88604-3	3"	374.00	
88606-4	4"	794.00	
<b>ADD FOR OPTIONS:</b>			
-40 .....\$112.00			







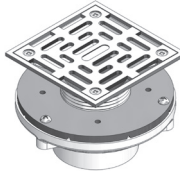

	88970 FRESH AIR INLET	
	LIST PRICE	
	PIPE SIZE	
	4"	\$1,302.00
	5"	1,483.00
<b>ADD FOR OPTIONS:</b>		
-8-2 ..... Deduct \$468.00    -VP .....\$93.00		

	88900 AIR GAP	
	LIST PRICE	
	TYPE NO.	
	88900-1	\$432.00
	88900-2	432.00
88900-3	515.00	
88900-4	761.00	
88900-5	1,799.00	
<b>ADD FOR OPTIONS:</b>		
-40 .....\$299.00		

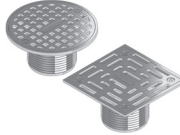
	88910 AIR GAP	
	LIST PRICE	
	PIPE SIZE	
	88910-1	\$444.00
	88910-2	444.00
88910-3	485.00	
88910-4	618.00	
88910-5	618.00	
<b>ADD FOR OPTIONS:</b>		
-40 .....\$299.00		

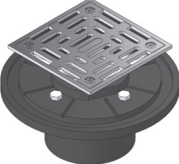
### Option Descriptions

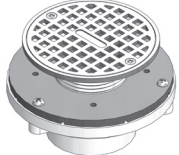



- ARE    Acid-Resisting Epoxy
- VP    Secured Grate, Vandal-Proof Screws
- 2    Satin Finish Bronze Face
- 8    All Bronze
- 8-2    All Bronze with Satin Finish Face
- 10    Polished Chrome Plated
- 40    Galvanized Cast Iron Parts
- 49    3/4" Primer Tap
- 50    1/2" Primer Tap
- 51    Flushing Tap
- 60    Bronze Plug
- 72    Bronze Bucket
- 90    1/2" Female Copper Connection
- 91    1/2" Female Copper Union Connection

 <p><b>FD-100-A</b></p>	<p><b>LEVEZE® II C.I. BODY w/5" ROUND TOP w/TWO-STAGE HEIGHT ADJUSTMENT</b></p> <table border="1"> <thead> <tr> <th colspan="2">LIST PRICE</th> </tr> <tr> <th>PIPE SIZE</th> <th>FD-100-A</th> </tr> </thead> <tbody> <tr> <td>2"-5"*</td> <td>\$608.00</td> </tr> </tbody> </table> <p>ADD FOR OPTIONS:</p> <table border="1"> <tr> <td>-TSI†</td> <td>POA</td> <td>-Y</td> <td>\$0.00</td> </tr> <tr> <td>-VP</td> <td>\$27.00</td> <td>-Z</td> <td>0.00</td> </tr> </table> <p>* 5" available in no-hub only    †Available up to 4" only</p>	LIST PRICE		PIPE SIZE	FD-100-A	2"-5"*	\$608.00	-TSI†	POA	-Y	\$0.00	-VP	\$27.00	-Z	0.00	 <p><b>FD-210-4CP-SQ</b></p>	<p><b>PVC BODY w/SOLVENT WELD OUTLET AND 4" ADJUSTABLE SQUARE CHROME PLATED BRASS STRAINER</b></p> <table border="1"> <thead> <tr> <th colspan="2">LIST PRICE</th> </tr> <tr> <th>PIPE SIZE</th> <th>FD-210-4CP-SQ</th> </tr> </thead> <tbody> <tr> <td>2", 3", 4"</td> <td>\$350.00</td> </tr> </tbody> </table> <p>ADD FOR OPTIONS:</p> <table border="1"> <tr> <td>-TSI</td> <td>POA</td> </tr> </table>	LIST PRICE		PIPE SIZE	FD-210-4CP-SQ	2", 3", 4"	\$350.00	-TSI	POA																															
LIST PRICE																																																								
PIPE SIZE	FD-100-A																																																							
2"-5"*	\$608.00																																																							
-TSI†	POA	-Y	\$0.00																																																					
-VP	\$27.00	-Z	0.00																																																					
LIST PRICE																																																								
PIPE SIZE	FD-210-4CP-SQ																																																							
2", 3", 4"	\$350.00																																																							
-TSI	POA																																																							
 <p><b>FD-100-S</b></p>	<p><b>LEVEZE® II C.I. BODY w/5" SQUARE TOP w/TWO-STAGE HEIGHT ADJUSTMENT</b></p> <table border="1"> <thead> <tr> <th colspan="2">LIST PRICE</th> </tr> <tr> <th>PIPE SIZE</th> <th>FD-100-S</th> </tr> </thead> <tbody> <tr> <td>2"-5"*</td> <td>\$709.00</td> </tr> </tbody> </table> <p>ADD FOR OPTIONS:</p> <table border="1"> <tr> <td>-TSI†</td> <td>POA</td> <td>-Y</td> <td>\$0.00</td> </tr> <tr> <td>-VP</td> <td>\$27.00</td> <td>-Z</td> <td>0.00</td> </tr> </table> <p>* 5" available in no-hub only    †Available up to 4" only</p>	LIST PRICE		PIPE SIZE	FD-100-S	2"-5"*	\$709.00	-TSI†	POA	-Y	\$0.00	-VP	\$27.00	-Z	0.00	 <p><b>4CP &amp; 4CP-SQ</b></p>	<p><b>REPLACEMENT CHROME PLATED STRAINERS FOR FD-200 &amp; FD-210 SERIES</b></p> <table border="1"> <thead> <tr> <th colspan="2">LIST PRICE</th> </tr> <tr> <th>4CP 4CP-SQ</th> <th></th> </tr> </thead> <tbody> <tr> <td></td> <td>\$223.00 257.00</td> </tr> </tbody> </table> <p>ADD FOR OPTIONS:</p> <table border="1"> <tr> <td>-TSI</td> <td>POA</td> </tr> </table>	LIST PRICE		4CP 4CP-SQ			\$223.00 257.00	-TSI	POA																															
LIST PRICE																																																								
PIPE SIZE	FD-100-S																																																							
2"-5"*	\$709.00																																																							
-TSI†	POA	-Y	\$0.00																																																					
-VP	\$27.00	-Z	0.00																																																					
LIST PRICE																																																								
4CP 4CP-SQ																																																								
	\$223.00 257.00																																																							
-TSI	POA																																																							
 <p><b>FD-200-4CP</b></p>	<p><b>CAST IRON BODY w/4" ADJUSTABLE ROUND CHROME PLATED BRASS STRAINER</b></p> <table border="1"> <thead> <tr> <th colspan="2">LIST PRICE</th> </tr> <tr> <th>PIPE SIZE</th> <th>FD-200-4CP</th> </tr> </thead> <tbody> <tr> <td>2"</td> <td>\$331.00</td> </tr> </tbody> </table> <p>ADD FOR OPTIONS:</p> <table border="1"> <tr> <td>-ST</td> <td>\$248.00</td> <td>-TSI</td> <td>POA</td> </tr> <tr> <td>-T</td> <td>0.00</td> <td>-Z</td> <td>0.00</td> </tr> </table>	LIST PRICE		PIPE SIZE	FD-200-4CP	2"	\$331.00	-ST	\$248.00	-TSI	POA	-T	0.00	-Z	0.00	 <p><b>FD-220</b></p>	<p><b>CAST IRON BODY w/6" SLOTTED CAST IRON, MEDIUM-DUTY GRATE</b></p> <table border="1"> <thead> <tr> <th colspan="2">LIST PRICE</th> </tr> <tr> <th>PIPE SIZE</th> <th>FD-220</th> </tr> </thead> <tbody> <tr> <td>2" Push-On (-Y)</td> <td>\$142.00</td> </tr> <tr> <td>3" No-Hub</td> <td>142.00</td> </tr> </tbody> </table> <p>ADD FOR OPTIONS:</p> <table border="1"> <tr> <td>-TSI</td> <td>POA</td> </tr> </table>	LIST PRICE		PIPE SIZE	FD-220	2" Push-On (-Y)	\$142.00	3" No-Hub	142.00	-TSI	POA																													
LIST PRICE																																																								
PIPE SIZE	FD-200-4CP																																																							
2"	\$331.00																																																							
-ST	\$248.00	-TSI	POA																																																					
-T	0.00	-Z	0.00																																																					
LIST PRICE																																																								
PIPE SIZE	FD-220																																																							
2" Push-On (-Y)	\$142.00																																																							
3" No-Hub	142.00																																																							
-TSI	POA																																																							
 <p><b>FD-200-4CP-SQ</b></p>	<p><b>CAST IRON BODY w/4" ADJUSTABLE SQUARE CHROME PLATED BRASS STRAINER</b></p> <table border="1"> <thead> <tr> <th colspan="2">LIST PRICE</th> </tr> <tr> <th>PIPE SIZE</th> <th>FD-200-4CP-SQ</th> </tr> </thead> <tbody> <tr> <td>2"</td> <td>\$366.00</td> </tr> </tbody> </table> <p>ADD FOR OPTIONS:</p> <table border="1"> <tr> <td>-ST</td> <td>\$248.00</td> <td>-TSI</td> <td>POA</td> </tr> <tr> <td>-T</td> <td>0.00</td> <td>-Z</td> <td>0.00</td> </tr> </table>	LIST PRICE		PIPE SIZE	FD-200-4CP-SQ	2"	\$366.00	-ST	\$248.00	-TSI	POA	-T	0.00	-Z	0.00	 <p><b>FD-250J-A</b></p>	<p><b>CAST IRON BODY w/ADJUSTABLE ROUND NIKALOY STRAINER AND NO-HUB BOTTOM OUTLET</b></p> <table border="1"> <thead> <tr> <th colspan="5">LIST PRICE</th> </tr> <tr> <th rowspan="2">PIPE SIZE</th> <th colspan="4">WITH STRAINER</th> </tr> <tr> <th>5A</th> <th>6A</th> <th>7A</th> <th>8A</th> </tr> </thead> <tbody> <tr> <td>4"</td> <td>\$440.00</td> <td>\$568.00</td> <td>\$671.00</td> <td>\$875.00</td> </tr> </tbody> </table> <p>ADD FOR OPTIONS:</p> <table border="1"> <tr> <td>-2</td> <td>Deduct \$38.00</td> <td>-CP (6A)</td> <td>\$148.00</td> </tr> <tr> <td>-80</td> <td>34.00</td> <td>-J</td> <td>159.00</td> </tr> <tr> <td>-92</td> <td>25.00</td> <td>-SS</td> <td>80.00</td> </tr> <tr> <td>-ARE</td> <td>30.00</td> <td>-TSI</td> <td>POA</td> </tr> <tr> <td>-CP (5A)</td> <td>148.00</td> <td>-VP</td> <td>27.00</td> </tr> </table>	LIST PRICE					PIPE SIZE	WITH STRAINER				5A	6A	7A	8A	4"	\$440.00	\$568.00	\$671.00	\$875.00	-2	Deduct \$38.00	-CP (6A)	\$148.00	-80	34.00	-J	159.00	-92	25.00	-SS	80.00	-ARE	30.00	-TSI	POA	-CP (5A)	148.00	-VP	27.00
LIST PRICE																																																								
PIPE SIZE	FD-200-4CP-SQ																																																							
2"	\$366.00																																																							
-ST	\$248.00	-TSI	POA																																																					
-T	0.00	-Z	0.00																																																					
LIST PRICE																																																								
PIPE SIZE	WITH STRAINER																																																							
	5A	6A	7A	8A																																																				
4"	\$440.00	\$568.00	\$671.00	\$875.00																																																				
-2	Deduct \$38.00	-CP (6A)	\$148.00																																																					
-80	34.00	-J	159.00																																																					
-92	25.00	-SS	80.00																																																					
-ARE	30.00	-TSI	POA																																																					
-CP (5A)	148.00	-VP	27.00																																																					
 <p><b>FD-210-4CP</b></p>	<p><b>PVC BODY w/SOLVENT WELD OUTLET AND 4" ADJUSTABLE ROUND CHROME PLATED BRASS STRAINER</b></p> <table border="1"> <thead> <tr> <th colspan="2">LIST PRICE</th> </tr> <tr> <th>PIPE SIZE</th> <th>FD-210-4CP</th> </tr> </thead> <tbody> <tr> <td>2", 3", 4"</td> <td>\$315.00</td> </tr> </tbody> </table> <p>ADD FOR OPTIONS:</p> <table border="1"> <tr> <td>-TSI</td> <td>POA</td> </tr> </table>	LIST PRICE		PIPE SIZE	FD-210-4CP	2", 3", 4"	\$315.00	-TSI	POA	 <p><b>FD-250J-S</b></p>	<p><b>CAST IRON BODY w/ADJUSTABLE SQUARE NIKALOY STRAINER AND NO-HUB BOTTOM OUTLET</b></p> <table border="1"> <thead> <tr> <th colspan="4">LIST PRICE</th> </tr> <tr> <th rowspan="2">PIPE SIZE</th> <th colspan="3">WITH STRAINER</th> </tr> <tr> <th>5S</th> <th>6S</th> <th>8S</th> </tr> </thead> <tbody> <tr> <td>4"</td> <td>\$630.00</td> <td>\$715.00</td> <td>\$1,093.00</td> </tr> </tbody> </table> <p>ADD FOR OPTIONS:</p> <table border="1"> <tr> <td>-2</td> <td>Deduct \$38.00</td> <td>-CP (6S)</td> <td>\$148.00</td> </tr> <tr> <td>-80</td> <td>34.00</td> <td>-J</td> <td>159.00</td> </tr> <tr> <td>-92</td> <td>25.00</td> <td>-SS</td> <td>80.00</td> </tr> <tr> <td>-ARE</td> <td>30.00</td> <td>-TSI</td> <td>POA</td> </tr> <tr> <td>-CP (5S)</td> <td>148.00</td> <td>-VP</td> <td>27.00</td> </tr> </table>	LIST PRICE				PIPE SIZE	WITH STRAINER			5S	6S	8S	4"	\$630.00	\$715.00	\$1,093.00	-2	Deduct \$38.00	-CP (6S)	\$148.00	-80	34.00	-J	159.00	-92	25.00	-SS	80.00	-ARE	30.00	-TSI	POA	-CP (5S)	148.00	-VP	27.00										
LIST PRICE																																																								
PIPE SIZE	FD-210-4CP																																																							
2", 3", 4"	\$315.00																																																							
-TSI	POA																																																							
LIST PRICE																																																								
PIPE SIZE	WITH STRAINER																																																							
	5S	6S	8S																																																					
4"	\$630.00	\$715.00	\$1,093.00																																																					
-2	Deduct \$38.00	-CP (6S)	\$148.00																																																					
-80	34.00	-J	159.00																																																					
-92	25.00	-SS	80.00																																																					
-ARE	30.00	-TSI	POA																																																					
-CP (5S)	148.00	-VP	27.00																																																					

# LITE LINE FLOOR DRAINS



A **WATTS** Brand

 <p><b>FD-300J-A</b></p>	<p><b>PVC 2-PIECE FLOOR DRAIN w/1/2" PRIMER TAP w/PLUG, SOLVENT WELD BOTTOM OUTLET FOR SCH 40 PVC PIPE AND ADJUSTABLE ROUND NIKALOY STRAINER</b></p> <table border="1"> <thead> <tr> <th colspan="5">LIST PRICE</th> </tr> <tr> <th>PIPE SIZE</th> <th colspan="4">WITH STRAINER</th> </tr> </thead> <tbody> <tr> <td rowspan="2">2", 3", 4"</td> <td>5A</td> <td>6A</td> <td>7A</td> <td>8A</td> </tr> <tr> <td>\$527.00</td> <td>\$654.00</td> <td>\$758.00</td> <td>\$963.00</td> </tr> </tbody> </table> <p><b>ADD FOR OPTIONS:</b></p> <p>-2 ..... Deduct \$38.00    -TSI ..... POA          -49 ..... 111.00    -VP ..... 27.00          -CP ..... 148.00</p>	LIST PRICE					PIPE SIZE	WITH STRAINER				2", 3", 4"	5A	6A	7A	8A	\$527.00	\$654.00	\$758.00	\$963.00	 <p><b>FD-370</b></p>	<p><b>PVC FLOOR DRAIN w/FLANGE, 9" PVC GRATE AND SOLVENT WELD BOTTOM OUTLET FOR SCH 40 PVC PIPE</b></p> <table border="1"> <thead> <tr> <th colspan="2">LIST PRICE</th> </tr> <tr> <th>PIPE SIZE</th> <th>FD-370</th> </tr> </thead> <tbody> <tr> <td>2", 3", 4"</td> <td>\$520.00</td> </tr> </tbody> </table> <p><b>ADD FOR OPTIONS:</b></p> <p>-49 ..... \$111.00    -HG ..... \$0.00          -50 ..... 111.00    -TSI ..... POA          -B ..... 117.00</p>	LIST PRICE		PIPE SIZE	FD-370	2", 3", 4"	\$520.00					
LIST PRICE																																	
PIPE SIZE	WITH STRAINER																																
2", 3", 4"	5A	6A	7A	8A																													
	\$527.00	\$654.00	\$758.00	\$963.00																													
LIST PRICE																																	
PIPE SIZE	FD-370																																
2", 3", 4"	\$520.00																																
 <p><b>FD-300J-S</b></p>	<p><b>PVC 2-PIECE FLOOR DRAIN w/ 1/2" PRIMER TAP w/PLUG, SOLVENT WELD BOTTOM OUTLET FOR SCH 40 PVC PIPE AND ADJUSTABLE SQUARE NIKALOY STRAINER</b></p> <table border="1"> <thead> <tr> <th colspan="4">LIST PRICE</th> </tr> <tr> <th>PIPE SIZE</th> <th colspan="3">WITH STRAINER</th> </tr> </thead> <tbody> <tr> <td rowspan="2">2", 3", 4"</td> <td>5S</td> <td>6S</td> <td>8S</td> </tr> <tr> <td>\$719.00</td> <td>\$805.00</td> <td>\$1,180.00</td> </tr> </tbody> </table> <p><b>ADD FOR OPTIONS:</b></p> <p>-2 ..... Deduct \$38.00    -TSI ..... POA          -49 ..... 111.00    -VP ..... 27.00          -CP ..... 148.00</p>	LIST PRICE				PIPE SIZE	WITH STRAINER			2", 3", 4"	5S	6S	8S	\$719.00	\$805.00	\$1,180.00	 <p><b>FD-400</b></p>	<p><b>PVC FLOOR DRAIN w/SOLVENT WELD BOTTOM OUTLET FOR SCH 40 PVC PIPE AND 5" ADJUSTABLE ROUND STRAINER</b></p> <table border="1"> <thead> <tr> <th colspan="3">LIST PRICE</th> </tr> <tr> <th>PIPE SIZE</th> <th colspan="2">WITH STRAINER</th> </tr> </thead> <tbody> <tr> <td>3" x 4"</td> <td>-J5PVC</td> <td>\$159.00</td> </tr> <tr> <td>3" x 4"</td> <td>-J5NB Nickel Bronze</td> <td>174.00</td> </tr> <tr> <td>3" x 4"</td> <td>-J5SC Scoriated Gasketed Solid Cover</td> <td>174.00</td> </tr> </tbody> </table> <p><b>ADD FOR OPTIONS:</b></p> <p>-TSI ..... POA    -VP ..... \$27.00</p>	LIST PRICE			PIPE SIZE	WITH STRAINER		3" x 4"	-J5PVC	\$159.00	3" x 4"	-J5NB Nickel Bronze	174.00	3" x 4"	-J5SC Scoriated Gasketed Solid Cover	174.00
LIST PRICE																																	
PIPE SIZE	WITH STRAINER																																
2", 3", 4"	5S	6S	8S																														
	\$719.00	\$805.00	\$1,180.00																														
LIST PRICE																																	
PIPE SIZE	WITH STRAINER																																
3" x 4"	-J5PVC	\$159.00																															
3" x 4"	-J5NB Nickel Bronze	174.00																															
3" x 4"	-J5SC Scoriated Gasketed Solid Cover	174.00																															
 <p><b>FD-310</b></p>	<p><b>CAST IRON 2-PIECE FLOOR DRAIN w/1/2" TRAP PRIMER w/PLUG AND 5" ADJUSTABLE ROUND NIKALOY STRAINER</b></p> <table border="1"> <thead> <tr> <th colspan="3">LIST PRICE</th> </tr> <tr> <th>TYPE NO.</th> <th>PIPE SIZE</th> <th></th> </tr> </thead> <tbody> <tr> <td>FD-312-Y</td> <td>2"</td> <td>\$340.00</td> </tr> <tr> <td>FD-312-Z</td> <td>2"</td> <td>340.00</td> </tr> <tr> <td>FD-313-Z</td> <td>3"</td> <td>340.00</td> </tr> <tr> <td>FD-313-Y</td> <td>3"</td> <td>340.00</td> </tr> <tr> <td>FD-314-Z</td> <td>4"</td> <td>340.00</td> </tr> </tbody> </table> <p><b>ADD FOR OPTIONS:</b></p> <p>-80 ..... \$38.00    -VP ..... \$27.00          -TSI ..... POA</p>	LIST PRICE			TYPE NO.	PIPE SIZE		FD-312-Y	2"	\$340.00	FD-312-Z	2"	340.00	FD-313-Z	3"	340.00	FD-313-Y	3"	340.00	FD-314-Z	4"	340.00	<p><b>Lite Line Floor Drain Option Descriptions</b></p> <ul style="list-style-type: none"> <li>-ARE    Acid-Resisting Epoxy</li> <li>-B        Bucket, PVC</li> <li>-CP      Chrome Plated</li> <li>-HG      1/2 Grate, PVC</li> <li>-J        Backwater Valve</li> <li>-MD     PVC Clamp Collar with 3" Socket Connection</li> <li>-SQ      Square Rim</li> <li>-SS      Stainless Steel</li> <li>-ST      Shallow Trap</li> <li>-TSI     Trap Seal Insert</li> <li>-VP      Secured Grate, Vandal-Proof Screws</li> <li>-2        Satin Finish Bronze Top</li> <li>-49      3/4" Primer Tap</li> <li>-50      1/2" Primer Tap</li> <li>-80      Perforated Stainless Steel Basket</li> <li>-92      Galvanized Cast Iron Parts</li> </ul> <p>Outlet</p> <ul style="list-style-type: none"> <li>-T        Threaded Outlet</li> <li>-Y        Hub Outlet with Gasket</li> <li>-Z        No-Hub Outlet</li> </ul>										
LIST PRICE																																	
TYPE NO.	PIPE SIZE																																
FD-312-Y	2"	\$340.00																															
FD-312-Z	2"	340.00																															
FD-313-Z	3"	340.00																															
FD-313-Y	3"	340.00																															
FD-314-Z	4"	340.00																															

**LITE LINE FLOOR DRAINS (cont'd.)**      **LITE LINE ROOF DRAINS**

**FD-450**



PVC FLOOR DRAIN w/SOLVENT WELD BOTTOM OUTLET FOR SCH 40 PVC PIPE AND 5" ADJUSTABLE ROUND STRAINER w/METAL RIM AND GRATE

LIST PRICE		
PIPE SIZE	WITH STRAINER	
3" x 4"	-J5NBRG Nickel Bronze Rim and Grate	\$331.00
3" x 4"	-J5PBRG Polished Bronze Rim and Grate	446.00
3" x 4"	-J5SCRG Scoriated Gasketed Solid Cover	331.00

ADD FOR OPTIONS:

-SQ.....\$0.00    -VP.....\$27.00  
-TSI.....POA

**FD-450J-A**



PVC FLOOR DRAIN w/SOLVENT WELD BOTTOM OUTLET FOR SCH 40 PVC PIPE AND ADJUSTABLE ROUND NIKALOY STRAINER

LIST PRICE				
PIPE SIZE	WITH STRAINER			
3" x 4"	5A	6A	7A	8A
		\$414.00	\$541.00	\$646.00

ADD FOR OPTIONS:

-2 ..... Deduct \$38.00    -VP.....\$27.00  
-TSI .....POA

**FD-450J-S**

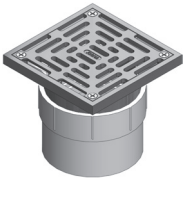

PVC FLOOR DRAIN w/SOLVENT WELD BOTTOM OUTLET FOR SCH 40 PVC PIPE AND ADJUSTABLE SQUARE NIKALOY STRAINER

LIST PRICE			
PIPE SIZE	WITH STRAINER		
3" x 4"	5S	6S	8S
		\$604.00	\$690.00

ADD FOR OPTIONS:

-2 ..... Deduct \$38.00    -VP.....\$27.00  
-TSI .....POA

**FD-500**



PVC FLOOR DRAIN w/SOLVENT WELD BOTTOM OUTLET FOR SCH 40 PVC PIPE AND 5" ADJUSTABLE ROUND STRAINER

LIST PRICE		
PIPE SIZE	WITH STRAINER	
2", 3", 4"	-JJ5PVC	\$128.00
2", 3", 4"	-J5NB Nickel Bronze	128.00
2", 3", 4"	-J5SC Scoriated Gasketed Solid Cover	142.00

ADD FOR OPTIONS:

-TSI .....POA

**RD-300**

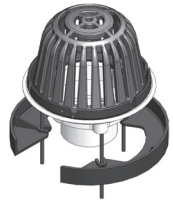

PVC BODY w/CAST IRON CLAMP RING, CAST IRON DOME AND SOLVENT WELD BOTTOM OUTLET

LIST PRICE	
PIPE SIZE	RD-300
2", 3", 4"	\$528.00

ADD FOR OPTIONS:

-17 .....\$213.00    -UC.....\$166.00  
-R.....166.00    -VP.....27.00  
-RC .....93.00

**RD-700**



FITS ALL CLAMP RING AND HARDWARE FOR BOLT CENTERS 7-1/2" TO 11"

LIST PRICE	
RD-700	\$515.00

**RD-700 TOP ASSY.**



FITS ALL TOP ASSEMBLY w/CAST IRON CLAMP RING, LARGE DOME AND HARDWARE

LIST PRICE		
700-AD	Aluminum Dome	\$929.00
700-CD	Cast Iron Dome	904.00
700-PD	Polypropylene Dome	771.00

ADD FOR OPTIONS:

-VP.....\$27.00

**Lite Line Floor Drains Option Descriptions**

- SQ    Square Rim
- TSI    Trap Seal Insert
- VP    Secured Grate, Vandal-Proof Screws
- 2    Satin Finish Bronze Top

**Lite Line Roof Drains Option Descriptions**

- R    Drain Receiver
- RC    Drain Receiver and Clips
- UC    Underdeck Clamp
- VP    Secured Dome, Vandal-Proof Screws
- 17    2" High Overflow Collar



LITE LINE FLOOR SINKS	LITE LINE CLEANOUTS
-----------------------	---------------------

	<b>FS-940</b> 12x12x6 PVC FLOOR SINK w/ MEDIUM-DUTY FULL PVC GRATE, ALUMINUM INTERNAL DOME STRAINER AND SOLVENT WELD OUTLET FOR SCH 40 PVC PIPE	
	LIST PRICE	
	PIPE SIZE	FS-940
	2", 3", 4"	\$773.00
	ADD FOR OPTIONS:	

-3Q .....	\$0.00	-NB .....	\$1,080.00
-HG .....	0.00	-TSI .....	POA
-LG .....	Deduct 193.00		

	<b>FS-100</b> 8x8x6 ACID-RESISTING INTERIOR FLOOR SINK AND FULL GRATE w/ALUMINUM INTERNAL DOME STRAINER AND NO-HUB OUTLET	
	LIST PRICE	
	PIPE SIZE	FS-100
	2", 3", 4"	\$1,155.00
	ADD FOR OPTIONS:	

-3 .....	\$0.00	-33 .....	\$476.00
-4 .....	0.00	-LG .....	Deduct 300.00
-31 .....	296.00	-TSI .....	POA

	<b>FS-120</b> 12x12x6 ACID-RESISTING INTERIOR FLOOR SINK AND FULL GRATE w/ALUMINUM INTERNAL DOME STRAINER AND NO-HUB OUTLET	
	LIST PRICE	
	PIPE SIZE	FS-120
	2", 3", 4"	\$1,220.00
	ADD FOR OPTIONS:	

-3 .....	\$0.00	-33 .....	\$520.00
-4 .....	0.00	-LG .....	Deduct 343.00
-31 .....	375.00	-TSI .....	POA

	<b>FS-140</b> 12x12x8 ACID-RESISTING INTERIOR FLOOR SINK AND FULL GRATE w/ALUMINUM INTERNAL DOME STRAINER AND NO-HUB OUTLET	
	LIST PRICE	
	PIPE SIZE	FS-140
	2", 3", 4"	\$1,303.00
	ADD FOR OPTIONS:	

-3 .....	\$0.00	-33 .....	\$520.00
-4 .....	0.00	-LG .....	Deduct 343.00
-31 .....	375.00	-TSI .....	POA

	<b>FS-160</b> 12x12x10 ACID-RESISTING INTERIOR FLOOR SINK AND FULL GRATE w/ALUMINUM INTERNAL DOME STRAINER AND NO-HUB OUTLET	
	LIST PRICE	
	PIPE SIZE	FS-160
	2", 3", 4"	\$1,737.00
	ADD FOR OPTIONS:	

-3 .....	\$0.00	-33 .....	\$520.00
-4 .....	0.00	-LG .....	Deduct 343.00
-31 .....	375.00	-TSI .....	POA

	<b>CO-100-A</b> LEVEZE® II C.I. CLEANOUT w/5" ROUND TOP, INTERNAL PLUG AND TWO-STAGE HEIGHT ADJUSTMENT	
	LIST PRICE	
	PIPE SIZE	CO-100-A
	2"-5"*	\$608.00
	ADD FOR OPTIONS:	

-VP .....	\$27.00	-Z .....	\$0.00
-Y .....	0.00		

\*5" available in no-hub only

	<b>CO-100-S</b> LEVEZE® II C.I. CLEANOUT w/5" SQUARE TOP, INTERNAL PLUG AND TWO-STAGE HEIGHT ADJUSTMENT	
	LIST PRICE	
	PIPE SIZE	CO-100-S
	2"-5"*	\$709.00
	ADD FOR OPTIONS:	

-VP .....	\$27.00	-Z .....	\$0.00
-Y .....	0.00		

\*5" available in no-hub only

	<b>CO-310</b> CAST IRON CLEANOUT, ADJUSTABLE NIKALOY RIM AND COVER AND INTEGRAL GAS-TIGHT THREADED PLUG		
	LIST PRICE		
	TYPE NO.	PIPE SIZE	
	CO-312-Y	2"	\$340.00
	CO-312-Z	2"	340.00
CO-313-Z	3"	340.00	
CO-313-Y	3"	340.00	
CO-314-Z	4"	340.00	
ADD FOR OPTIONS:			

-SQ Square Nickel Bronze Rim and Cover .....	\$38.00
-VP Secured Cover, Vandal-Proof Screws .....	27.00

	<b>CO-430</b> PVC CLEANOUT w/ROUND (NIKALOY or CAST IRON) TOP w/BRONZE PLUG AND SOLVENT WELD BOTTOM OUTLET FOR FITTING OVER 3" AND INSIDE 4" SCH 40 DWV	
	LIST PRICE	
	PIPE SIZE	CO-430
	3" x 4" - Nikaloy	\$579.00
	3" x 4" - Cast Iron	737.00
ADD FOR OPTIONS:		

-2* .....	Deduct \$38.00	-VP .....	\$27.00
-14 .....	60.00		

\*For Nikaloy Top only

	<b>CO-600</b> CAST IRON CLEANOUT w/SECURED ROUND CAST IRON RIM AND COVER w/INTEGRAL BRASS PLUG AND 4" NO-HUB OUTLET		
	LIST PRICE		
	PIPE SIZE	WITH STRAINER	
	4"	-CI Rim and Cover (Std)	\$686.00
	4"	-NB Nikaloy Rim and Cover	742.00
4"	-NB-SQ Square Nikaloy Rim and Cover	742.00	

Lite Line Cleanout Option Descriptions	
-2 Satin Finish Bronze Top	-VP Secured Cover, Vandal-Proof Screws
-14 Carpet Cleanout Marker	Outlets
-SQ Square Nickel Bronze Rim and Cover	-Y Hub Outlet w/Gasket 2" - 4"
	-Z No-Hub Outlet

Lite Line Floor Sink Option Descriptions

- HG 1/2 Grate (PVC)
- 3Q 3/4 Grate (PVC)
- LG Less Grate
- NB Nickel Bronze
- TSI Trap Seal Insert
- 3 1/2 Grate (Acid-Resisting)
- 4 3/4 Grate (Acid-Resisting)
- 31 Aluminum Sediment Bucket
- 33 Acid-Resisting Finish Sediment Bucket

**LITE LINE GREASE INTERCEPTORS**

	<b>MANUAL CLEANING ON-FLOOR TYPE</b>					
	TYPE NO.	PIPE SIZE	FLOW RATE GPM	GREASE CAPACITY LBS.	LIST PRICE	FOR OPTION, ADD TO LIST PRICE
						-EXT 6"
	JG-0102S	2	7	14	\$3,047.00	\$2,170.00
	JG-0103S	2	10	20	3,477.00	2,752.00
	JG-0104S	2	15	30	4,123.00	2,897.00
	JG-0105S	3	20	40	4,635.00	3,137.00
	JG-0106S	3	25	50	6,276.00	3,379.00
	JG-0107S	3	35	70	7,526.00	3,960.00
	JG-0108S	3	50	100	8,609.00	6,276.00
JG-0109S	3	75	150	17,966.00	10,618.00	
JG-0110S	4	100	200	22,049.00	12,063.00	
<b>ADD FOR OPTIONS:</b>						
-EXT ..... ABOVE						

**LITE LINE SHOCK ABSORBERS**

	<b>COPPER SHELL SHOCK ABSORBERS</b>		
	SIZE	PIPE CONNECTION	LIST PRICE
	SA-A	1/2	\$216.00
	SA-B	3/4	249.00
	SA-C	1	530.00
	SA-D	1	631.00
	SA-E	1	1,416.00
SA-F	1	2,130.00	

**LITE LINE SHALLOW TRENCH DRAIN PRODUCTS**

Part Number	Channel Size	Grate	Grate Size	Load Class	ADA/HP	List Price Per Foot*
TD-130-ABS	39.4"	ABS Perforated	19.7"	A	ADA/HP	\$248.00
TD-130-GALV	39.4"	Galvanized Steel Slotted	39.4"	A	ADA	\$291.00
TD-130-SS	39.4"	Stainless Steel Slotted	39.4"	A	ADA	\$528.00
TD-130-CI	39.4"	Cast Iron Diagonal Slotted	19.7"	C	ADA	\$318.00

Above pricing includes Neutral HDPE Channel, Grate, and Lock Bar. \*Pricing is estimated per foot price. Final orders are to be rounded to nearest 39.4".

**ADD FOR OPTIONS:**

-ECS..... \$232.00	-110GSKT.....\$14.00	-SSE.....\$246.00*	-GSE.....\$116.00*
-GABS.....\$181.00	-GGALV.....\$326.00	-GSS.....\$1,159.00	-GCI.....\$348.00
			-LBK**.....\$26.00

\*This pricing is estimated per foot price. Final orders are to be rounded to nearest 39.4". \*\*Required every 19.7" when ordering replacement grates.

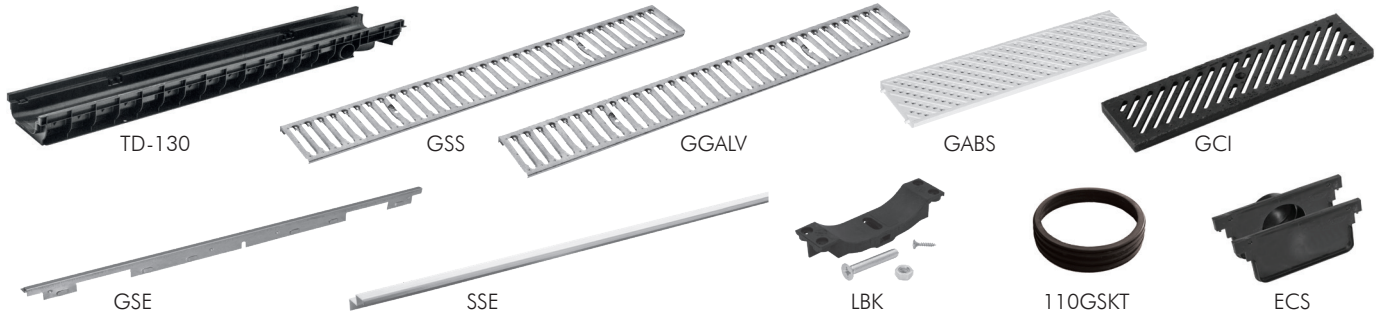

**Lite Line Trench Drain Option Descriptions**

-TD-130	Channel	-ECS	End Cap Set
-GABS	ABS Perforated Grate	-LBK	Lock Bar Kit
-GCI	Cast Iron Diagonal Slotted Grate	-110GSKT	Gasket
-GGALV	Galvanized Steel Slotted Grate	-SSE	Stainless Steel Edge
-GSS	Stainless Steel Slotted Grate	-GSE	Galvanized Steel Edge

## Superior Packaging, Labeling and Shipping

Josam ships its products pre-packaged, labeled with part numbers, and partially assembled at no extra charge!



Each item is individually wrapped and upon request tagged with specific product designations for easy on-site identification and transportation

---

Shrink wrapping protects product from harsh weather conditions and reduces lost parts

---

All Josam shrink wrap material is environmentally friendly and biodegradable



A **WATTS** Brand

T: (800) 365-6726 • [Josam.com](http://Josam.com)