

SPECIFICATION:

JOSAM PRE-FAB BASE OPTION FOR 49340A SERIES FLOOR SINKS.

-PFB OPTION MUST BE ORDERED AT TIME OF SINK ORDER FOR PROPER SINK BODY MODIFICATION.

**FLOOR SINK
PRE-FAB BASE**

SERIES / PART NO. **49340A-PFB**

NOTE: FLOOR SINK MUST HAVE FLANGE

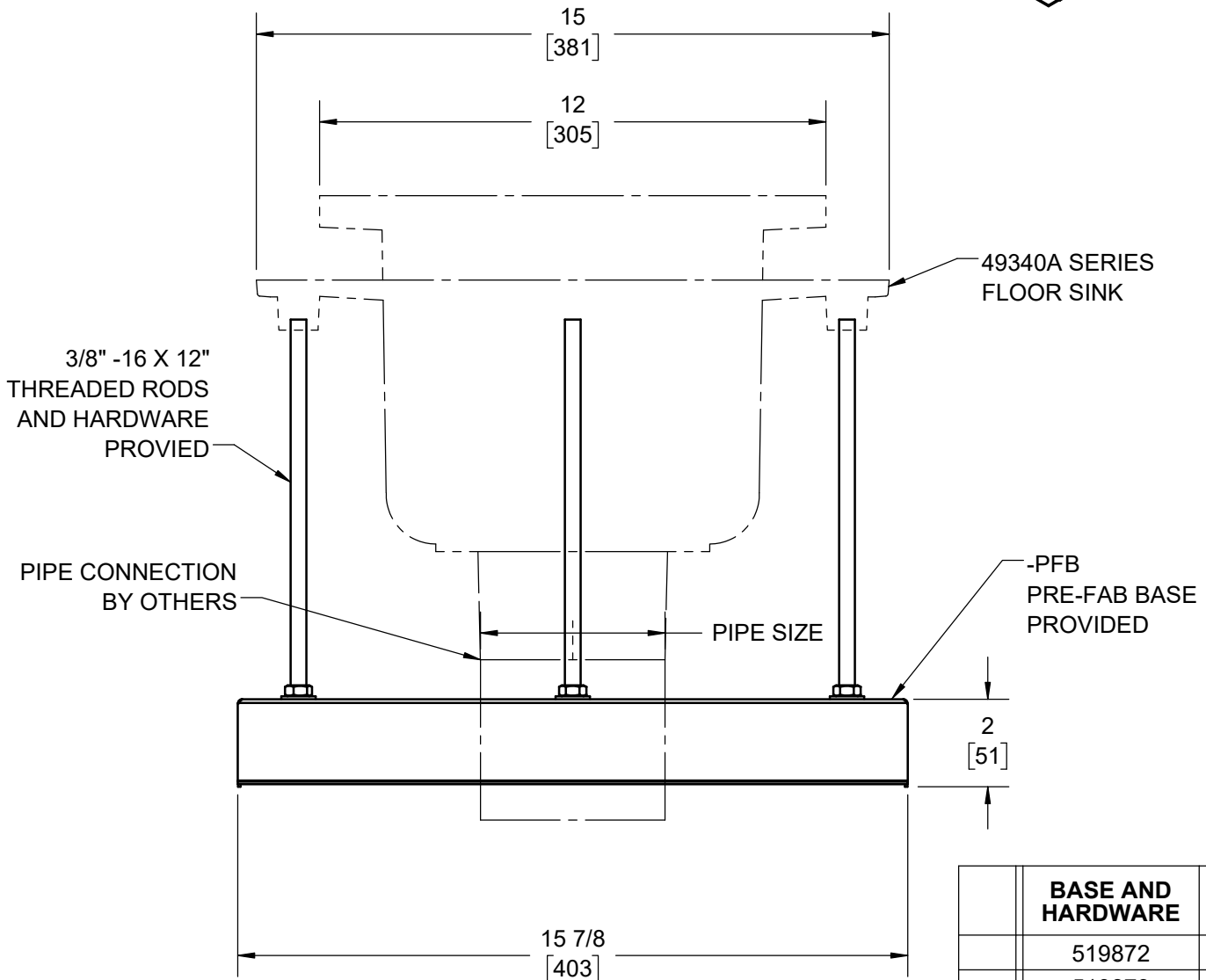
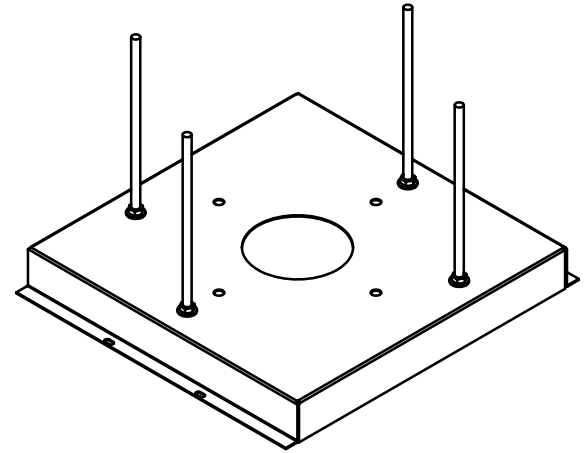

	BASE AND HARDWARE	PIPE SIZE
	519872	2"
	519873	3"
	519874	4"
	519876	6"

WARNING: Cancer and Reproductive Harm - www.P65Warnings.ca.gov

DATE OF LAST CHANGE: 2/7/2025 | BLK

DIMENSIONS ARE SUBJECT TO MANUFACTURERS TOLERANCES AND CHANGE WITHOUT NOTICE. WE CAN ASSUME NO RESPONSIBILITY FOR USE OF SUPERSEDED OR VOID DATA.



MICHIGAN CITY, INDIANA

NOTES